



Service Manual

A Series Modular-type Air-cooled (Heat Pump) Chiller

Contents





1 Safety Notice	1
2 Preface.....	1
3 Product Information.....	1
3.1 Introduction	1
3.1.1 Lineup	1
3.1.2 Model Number Nomenclature	1
3.1.3 Product Features	2
3.1.4 Nominal Operating Conditions.....	2
3.1.5 Operation Range.....	2
3.2 Unit Performance Curves	2
3.3 Working Principle	4
3.3.1 Principle Diagrams	4
3.4 Technical Parameters List.....	4
3.4.1 Electrical Parameters	4
3.4.2 Performance Parameters Table	4
3.5 Scope of Supply	5
3.6 Selection Statement.....	5
3.6.1 Selection Procedures	5
4 Unit Control	8
4.1 Schematic Diagram.....	8
4.2 Operation Flowchart.....	10
4.2.1 Cooling	10
4.2.2 Heating	11
4.3 Key Control Logics.....	11
4.3.1 Cooling Control.....	11
4.3.2 Heating Control.....	12
4.3.3 Automatic Anti-freezing Operation.....	12
4.3.4 Control to the Compressor	12
4.3.5 Control to the Fan.....	12
4.3.6 Control to the 4-way Valve	12
4.3.7 Control to the Water Pump	12
4.3.8 Control to the Electronic Expansion Valve.....	12
4.3.9 Protection.....	13
4.4 General Introduction.....	13
4.4.1 Homepage.....	14
4.4.2 Menu Page	15
4.4.3 Introduction to the Pop-up Windows	15
4.4.4 Backlight	16
4.5 Operation Instructions	16
4.5.1 On/Off.....	16
4.5.2 Functions.....	17
4.5.3 Parameter	24
4.5.4 Information	25
4.5.5 E-Clear	32
4.5.6 General.....	33
4.5.7 Setup of Toggle Switches on the Motherboard	36
4.6 Smart Management System.....	37
4.6.1 Long-distance Monitoring/BMS Interface	37
4.6.2 Network of the Long-distance Monitoring System	38
4.6.3 Hardware	39
4.6.4 Model Selection Instructions	39
5 Unit Installation.....	41
5.1 Installation Flowchart.....	41
5.2 Preparations before Installation	41
5.2.1 Precautions for Installation	41

5.2.2 Importance of Installation	42
5.2.3 Selection of Installation Materials	42
5.3 Tools	46
5.3.1 Cutting and Finishing Tools	46
5.3.2 Measuring Tools	46
5.4 Installation Instructions	48
5.4.1 Outline Dimensions	48
5.4.2 Precautions for Installation	48
5.4.3 Installation Environment	49
5.4.4 Installation and Service Space	49
5.4.5 Installation Foundation	49
5.4.6 Handling and Lifting	50
5.5 Piping and Insulation	51
5.5.1 Installation of the Water System	51
5.5.2 Requirements on Piping	53
5.5.3 Installation of the Expansion Tank	58
5.5.4 Installation of Condensate Pipes	59
5.6 Electric Wiring	61
5.6.1 Safety Precautions	61
5.6.2 Control Concept	61
5.6.3 Specification of Power Cord and Air Switch	62
5.6.4 Wiring of the Electric Control Cabinet	62
5.6.5 Filed Wiring	62
5.6.6 Networking and Wiring between Units	64
5.6.7 Electric Wiring Diagram	66
5.6.8 Jumpers	67
6 Commissioning	68
6.1 Flowchart of Commissioning	68
6.2 Safety Precautions for Commissioning	68
6.3 Preparation before Commissioning	68
6.3.1 Documents	68
6.3.2 Tools	68
6.3.3 Check before Commissioning	69
6.4 Initial Run	70
6.4.1 Check for Initial Run	70
7 Repair	70
7.1 Error List	70
7.2 Flow Chart of Troubleshooting	72
7.3 Power Distribution	76
7.3.1 Power Distribution Logic	76
7.3.2 Introduction to the Main Electric Element	77
7.3.3 Main Board	78
7.4 Replacement of Main Parts	79
7.4.1 Brief Introduction	79
7.4.2 Replacement Instructions	80
7.5 Routine Repair	89
7.5.1 Repairs to Refrigerant Leakage	89
7.5.2 Air Removal	91
7.6 Exploded Views and Part Lists	91
8 Maintenance	94
8.1 Significant of Maintenance	94
8.2 Maintenance Items	94
8.2.1 Routine Maintenance Items	94
8.2.2 Periodic Maintenance Items	95
8.3 Freeze Protection in Winter	96

1 Safety Notice

Safety symbols

The following symbols are used in this document to alert the reader to potential of hazard.

	WARNING indicates a potentially hazardous situation which, if not avoided, could result in damage to the machine as well as death or serious injury.
	CAUTION identifies a hazard which could lead to minimal or moderate damage to the machine as well as death or serious injury.
	BAN indicates a potentially hazardous situation which, if not avoided, could result in death or serious injury.
	COMPLIANCE identifies a hazard which could lead death or serious injury as well as damage to the property.

2 Preface

Thank you for selecting Gree's A Series Inverter Modular Air-cooled Chiller (Heat Pump). Please read this instruction manual carefully before installing and using the product and achieve operating effect, we hereby instruct as below:

The Manual is applied to A Series Inverter Modular Air-cooled Chiller (Heat Pump), specifying operation safety requirements, basic principles and implementation approaches for construction fulfillment, construction debug, after-sale maintenance and repairs. All works must be performed in accordance with the relevant national (and local) safety requirements and the Manual, which if not abided, could result in potential damage to the air conditioner, and even serious injury or death.

3 Product Information

3.1 Introduction

3.1.1 Lineup

Series	Model	Cooling capacity	Heating capacity	Power supply	Refrigerant	Diagram
		(KW)	(KW)			
A series inverter modular air-cooled chiller (heat pump)	LSQWRF35VM/NaA-M	32	36	380–415VAC 3Ph 50Hz	R410A	
	LSQWRF60VM/NaA-M	60	65			
	LSQWRF65VM/NaA-M	65	70			

3.1.2 Model Number Nomenclature

LS	QW	R	F	60	V	M	/	Na	A	—	M
1	2	3	4	5	6	7		8	9		10

No	Code description	Options
1	Unit	LS:chiller
2	Compressor type	QW: hermetic scroll/rotor type
3	Unit function	Default:cooling only
		R:heat pump
4	Cooling method of condenser	F:air-cooled
5	Rated cooling capacity	Rated cooling capacity = number (kW)
6	Variable frequency	Default-fixed speed
7	Assembly method	M:modular
8	Refrigerant type	Na:R410A
9	Design code	A-Z alphabetic order
10	Power code	380–415VAC 3Ph 50HZ

For instance, LSQWRF60VM/NaA-M indicates an inverter modular air-cooled chiller with a fully enclosed rotor-type compressor, featuring 60kW cooling capacity and using R410A refrigerant (Lengshui, Quanfengbi, Woxuan/Zhuanzi, Rebeng, Fengleng, 60kW, Variable speed, Modular, R410A, A, 380–415V~3N~50HZ)

3.1.3 Product Features

The all-inverter modular air-cooled chillers work outstandingly by virtue of their major features stated below..

■Excellent compatibility :

The all-inverter modular air-cooled chillers can be constructed of multiple single units with the same or different structure or capability (30kW, 60kW, 65kW). For the 35kW unit, it has only one cooling system; for the 60kW, 65kW units, they are of two independent systems. Up to 16 single units can be modularized, with cooling capacity ranging from 35kW to 1040kW.

■Comfort and energy saving :

The variable-frequency technology can quickly respond to load change and lead to decreased water temperature fluctuation and better comfort.

■Ultra-quiet :

The high-efficiency and low-noise fan blades and motor as well as the optimized air passage can greatly lower operation noise of the unit. Besides, the quiet mode can provide the user a ultra-quiet environment.

■Powerful self-protection :

It is equipped with the top-end microcomputer control system which is capable of providing well-rounded protection and self-diagnosis.

■High reliability :

It is constructed of well-designed refrigeration parts and well-designed system, structure and electric control, adequately guaranteeing reliable operation

■Remote ON/OFF :

The unit can be started or stopped by the ON/OFF key operation.

■Equilibrium running :

It indicates each compressor will run alternately so as to extend their service life.

■Shiftwork of water pumps :

Two water pumps can work alternately with equilibrium runtime so as to extend their service life and lower the maintenance difficulty.

3.1.4 Nominal Operating Conditions

Item	Water side		Air side	
	Water flow m3/ (h·kW)	Outlet temperature (°C)	Dry bulb temperature (°C)	Wet bulb temperature (°C)
Cooling	0.172	7	35	—
Heat pump		45	7	6

3.1.5 Operation Range

Please run the unit under the specified operation range as shown in the table below:

■R410A Series

Item	Water Side		Air Side
	Leaving Water Temperature (°C)	Water Temperature Difference (°C)	Ambient DB Temperature (°C)
Cooling	5 ~ 20	2.5 ~ 6	-15 ~ 52
Heating	35 ~ 50	2.5 ~ 6	-20 ~ 40

maximum and minimum entering water pressures:

Item	Minimum entering water pressures	Maximum entering water pressures
Cooling	0.06MPa	1.6MPa
Heating		

3.2 Unit Performance Curves

Here are curves indicating the unit performances in cooling and heating states.

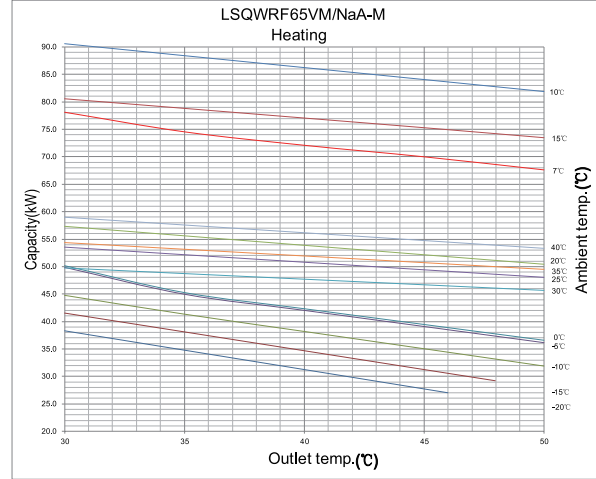
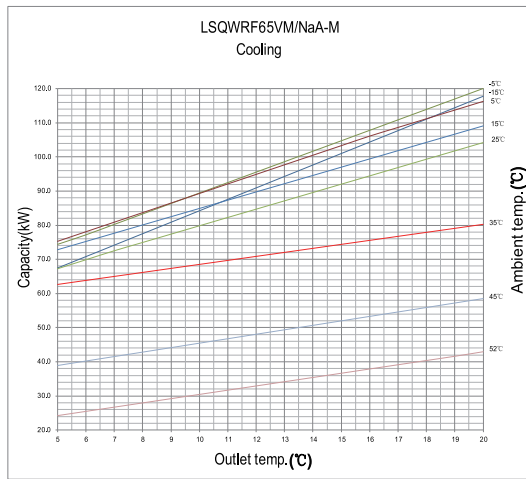
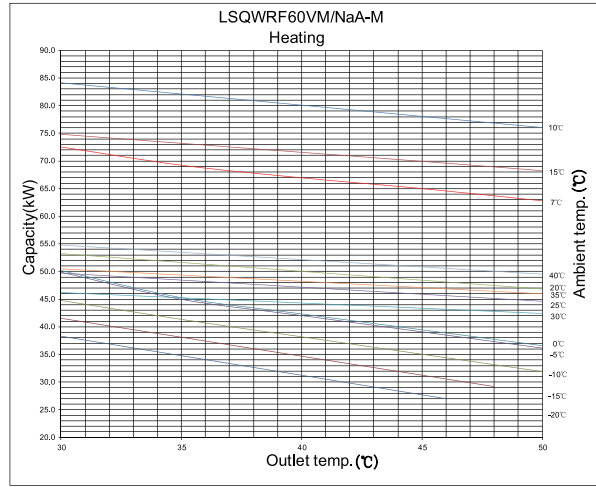
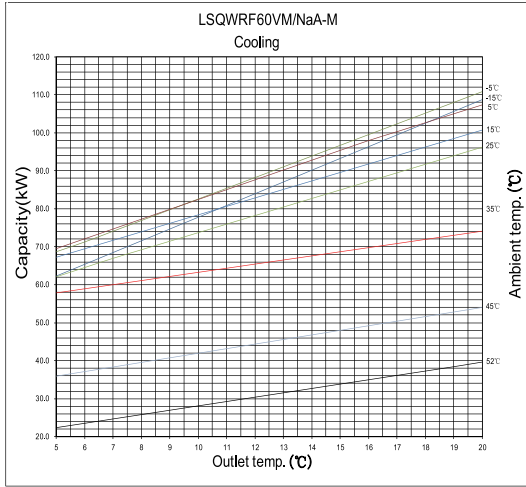
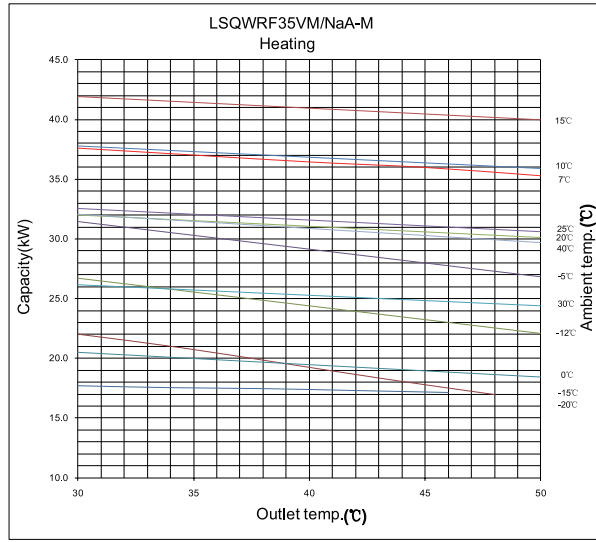
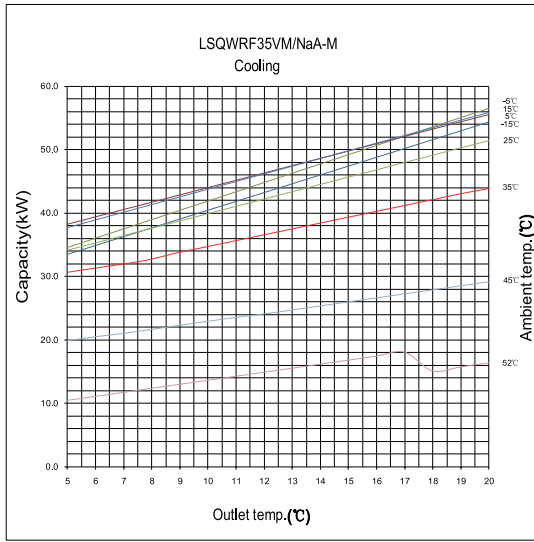

3.3 Working Principle

3.3.1 Principle Diagrams

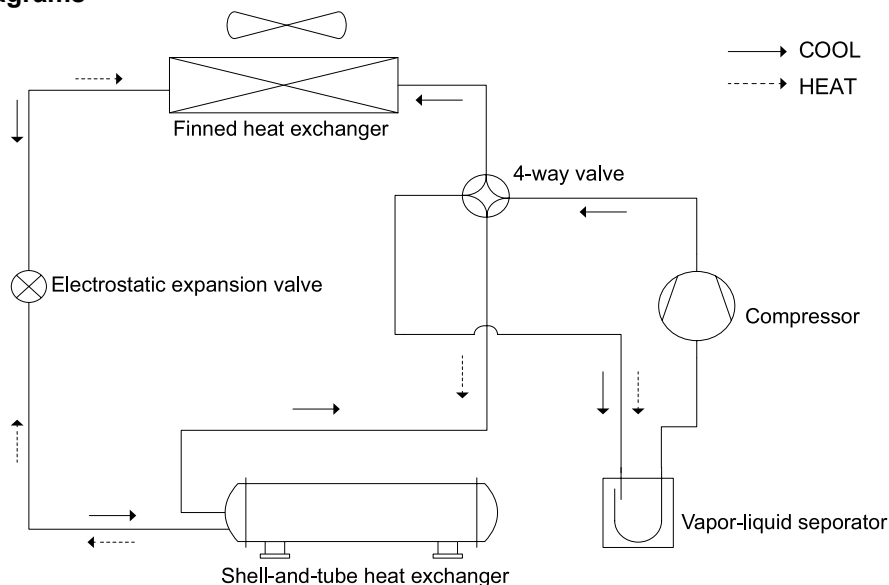

3.4 Technical Parameters List

3.4.1 Electrical Parameters

Electrical parameters table

Unit	Power supply	Compressor	MRC	NRC	Fan	NRC
		Quantity	(A)	(A)	Quantity	(A)
LSQWRF35VM/ NaA-M	380V~415VAC 3Ph 50Hz	1	30	17.5	2	0.7
LSQWRF60VM/ NaA-M	380V ~ 415VAC 3Ph 50Hz	2	30	17.5	2	1.28
LSQWRF65VM/ NaA-M	380V ~ 415VAC 3Ph 50Hz	2	30	17.5	2	1.28

Notes:

(1)MRC: Maximum Running Current (A)

(2)NRC: Nominal Running Current (A)

3.4.2 Performance Parameters Table

Model		LSQWRF35VM/NaA-M	LSQWRF60VM/NaA-M	LSQWRF65VM/NaA-M
Cooling capacity	kW	32	60	65
Heating capacity	kW	36	65	70
Rated cooling power	kW	12.4	21.9	24.8
Rated heating power	kW	10.8	20.2	21.9
Noise	dB(A)	62	68	68
Power supply		380—415V 3N ~ 50Hz		
Operation control		The microcomputer implementing fully automatic control, displaying the operation state and giving an alarm		
Safety controls		High-pressure and low-pressure safety cut-out, high-discharge temperature cut-out, antifreeze control, overflow control, phase safety device, water flow safety control, pressure sensor cut-out, temperature sensor cut-out, four-way valve safety control, compressor overheat control		
Compressor	Type	Fully enclosed rotor-type compressor		
	Quantity	1	2	2
	Starting mode	With variable frequency		
Water-side heat exchanger		High-efficiency shell and tube heat exchanger		
Water flow volume	wm ³ /h	5.5	10.32	11.18

	Water resistance	kPa	75	55	60
	The highest bearing pressure	MPa	4.6		
	Connection method		By external threads		
	Connection Thread	-	G1 1/2 external thread	G2 External thread	G2 External thread
Air	Air-side heat exchanger		High-efficiency finned coil heat exchanger		
	Rated power of fan	W	750×2	750×2	750×2
	Airflow volume	m ³ /h	1.26×10 ⁴	2.4×10 ⁴	2.4×10 ⁴
Outline dimension	Width	mm	1340	2200	2200
	Depth	mm	845	965	965
	Height	mm	1605	1675	1675
Wet weight		kg	400	689	689
Operating weight		kg	440	758	758

3.5 Scope of Supply

Item	Heat pump
Modules	S
Three-wire control lines (8m)	S
Accessories for the unit XE73-25/G	S (Additionally purchased)
Electric control cabinet	O
Auxiliary electric heater	O
Power lines	O
Control lines	O
Connecting hose	O
Thermometer	O
Pressure gauge	O

S= standard O= user prepared P= Optional

3.6 Selection Statement

3.6.1 Selection Procedures

Calculate the load for each separate area (cooling load and fresh air load)→Select the terminal unit→Select the main unit→Check the cooling load→Make a confirmation

3.6.1.1 Load Estimate

3.6.1.1.1 Cooling and Heating Load

Table 3.6.1 Cooling Load per Unit of Air Conditioning Area

Construction category	Room Type	Cooling load (W/ m ²)	Construction category	Room Type	Cooling load (W/m ²)
Hotel	Hotel, all	70 ~ 95	Hospital	Hospital, all	105 ~ 130
	Guest room	70 ~ 100		VIP ward	80 ~ 120
	Pub, cafe	80 ~ 120		Average ward	70 ~ 110
	West restaurant	100 ~ 160		Rooms for diagnosis, treatment and, injection	75 ~ 140
	Chinese restaurant, banquet hall	150 ~ 250		X-ray, CT and MRT Room	90 ~ 120
	Store	80 ~ 110		operation and delivery room	100 ~ 150
	Lounge	80 ~ 100		Clean operating room	180 ~ 380
	Atrium	100 ~ 180		Service hall	70 ~ 120
	Small meeting room (smoking area)	140 ~ 250	Department store	First floor/ground floor	160 ~ 280

A Series Modular-type Air-cooled (Heat Pump) Chiller

	Large meeting room (no smoking area)	100 ~ 200		Intermediate floor	150 ~ 200		
	Hairdressing room	90 ~ 140		Top floor	180 ~ 250		
	Gym	100 ~ 160		Department store	210 ~ 240		
	Bowling alley	90 ~ 150		Auditorium	180 ~ 280		
		Billiard room	75 ~ 110	Theater	Lounge (smoking area)	250 ~ 360	
		Swimming pool	160 ~ 260		Boudoir	80 ~ 120	
		Ball room	180 ~ 220		Hall and rest room	70 ~ 100	
		Disco	220 ~ 320		Arena	100 ~ 140	
			Karaoke hall	100 ~ 160	Stadium	VIP Room	120 ~ 180
			Playroom, office	70 ~ 120		Lounge (smoking area)	280 ~ 360
			Rest room	80 ~ 100		Lounge (no smoking area)	160 ~ 250
			Bank	Business hall		120 ~ 160	Lounge for judges, coaches and athletes
		Office	70 ~ 120	Office building	Deluxe office	120 ~ 160	
		Machine room	120 ~ 160		Average office	90 ~ 120	
Exhibition hall		150 ~ 200	Machine room		100 ~ 140		
Auditorium		160 ~ 240	Meeting room		150 ~ 200		
Multi-functional room		180 ~ 250	Reception room (smoking area)		180 ~ 260		
Library	Reading room	100 ~ 160	Hall and rest room		70 ~ 110		
	Service section	90 ~ 110	Office building		95 ~ 115		
	Stack room	70 ~ 90	Super high-rise building		105 ~ 145		
	Special collection room	100 ~ 150	Residential building	Multi-storey building	88 ~ 150		
Restaurant	Hall	200 ~ 280		High-rise	80 ~ 120		
	Individual dining room	180 ~ 250		Villa	150 ~ 220		
Supermarket	Service Hall	160 ~ 220					
	Meet and fish area	90 ~ 160					

Note: it is cited from *Practical Heating and Air Conditioning Design Manual*

Table 3.6.2 Cooling and Heating Load per Unit of Air Conditioning Area

Construction type		Heating and Cooling Load (W/m ²)				Loading Conditions				
		Total cooling capacity	Fresh air	Total heating capacity	Fresh air	Lighting (W/m ²)	Density (p/m ²)	Fresh air (m ³ /h)	Exfiltration (h-1)	
Bank	Business Hall	242	72	220	90	50	0.3	6	1.5	
	Reception Room	179	48	184	59	30	0.2	4	0.5	
Department store	First Floor/ground floor	355	97	246	107	80	0.8	8	2	
	Specialty store	307	121	161	134	60	1	10	0.5	
	Mall	217	97	137	107	60	0.4	8	0.5	
Supermarket	Food zone	212	72	195	80	60	0.6	6	0.5	
	Clothing zone	215	72	167	80	60	0.3	6	0.5	
Hotel	Banquet hall		449	260	312	299	80	1	20	0
	Facing direction of guest room facing direction	South	127	78	207	90	20	0.12	6	0.5
		West	131		207		20	0.12	6	0.5
		North	125		207		20	0.12	6	0.5
		East	130		207		20	0.12	6	0.5

Eating house	Restaurant	286	144	228	179	40	0.6	12	0.5	
Community center	Study	233	121	228	149	20	0.5	10	0.5	
Library	Reading Room	143	48	125	59	30	0.2	4	0.5	
Hospital	Facing direction of six-bed ward	South	91	48	112	59	15	0.2	4	0.5
		West	110		112		15	0.2	4	0.5
		North	79		112		15	0.2	4	0.5
		East	96		112		15	0.2	4	0.5
Theatre	Auditorium	512	362	506	448	25	1.5	30	0	
	Service Hall	237	78	219	90	30	0.3	6	0.5	

Table 3.6.3 Estimated Cooling Load per Unit Building Area

Construction type	Cooling load (W/m ²)	Cooling load (W/m ²)
Hotel	35 ~ 45	70 ~ 81
Large auditorium	56 ~ 72	/
Office building	42 ~ 54	84 ~ 98
Library, museum	18 ~ 32	35 ~ 41
Store	25 ~ 59	56 ~ 65 (only service hall)
Stadium	35 ~ 135	209 ~ 244 (as per the arena area)
Stadium		105 ~ 122 (as per the total area)
Cinema	42 ~ 68	84 ~ 98(only auditorium)
Theater	/	105 ~ 128
Hospital	28 ~ 45	58 ~ 81
Deluxe restaurant	/	105 ~ 116

Note: refer to *It is cited from Design and Troubleshooting for Heating and Cooling Air Conditioners.*

(1) Take the lower limit when the total building area is less than 5000m² and take the upper limit when the total building area is large than 10000 m².

(2) The estimated load directly indicates the required capacity of the air conditioners.

(3) Unless otherwise stated, the area always indicates the total building area no matter if air conditioning is for local area or not.

3.6.1.2 Calculation of Indoor Load Demand

Indoor load demand = room area (m²) × per unit load(W/m²)

Note: our products that will be selected with cooling loads should fit for the on-site situation.

3.6.1.3 Selection of a Terminal Unit

Select a proper terminal unit in accordance with requirements on load noise and installation space.

3.6.1.4 Selection of a Main Unit

A main unit should be selected based on its theoretically calculated cooling load.

3.6.1.5 Calculation of Heating Load

Calculate the heating loads of the main unit and terminal unit that have been selected, which is not expected to be recognized until satisfying the requirements.

3.6.1.6 A case for Selection

Background: there is an office building covering 12,000m² totally with 10,500m² to be air conditioned, among which the big meeting rooms take up 500m², the small meeting rooms take up 1,500m² and office rooms take up 8,500m², and fresh air is required.

(1) Calculate the cooling load

1) By the estimated cooling load:

Big meeting rooms: 500×180 (W/m²) =90000W=90kW

Small meeting rooms: 150×240 (W/m²) =360000W=360kW

Offices: 8600×150 (W/m²) = 1290000W = 1290kW

Total: 90kW+360kW + 1290kW=1740kW

2) By the building area:

$$12000 \times 98W = 1176kW$$

3) According to the calculation results of 1) and 2), cooling load 1740kW is selected.

(2) Calculate the heating load

By the estimated heating load:

$$12000 \times 70 = 840000W = 840kW$$

(3) Select the desired model and quantity

Look up the GREE Technical Guide Manual and it is concluded that 29 SQWRF60VM/NaA-M meet the design requirement (cooling load: 1740kW, heating load: 1885kW).

4 Unit Control

4.1 Schematic Diagram

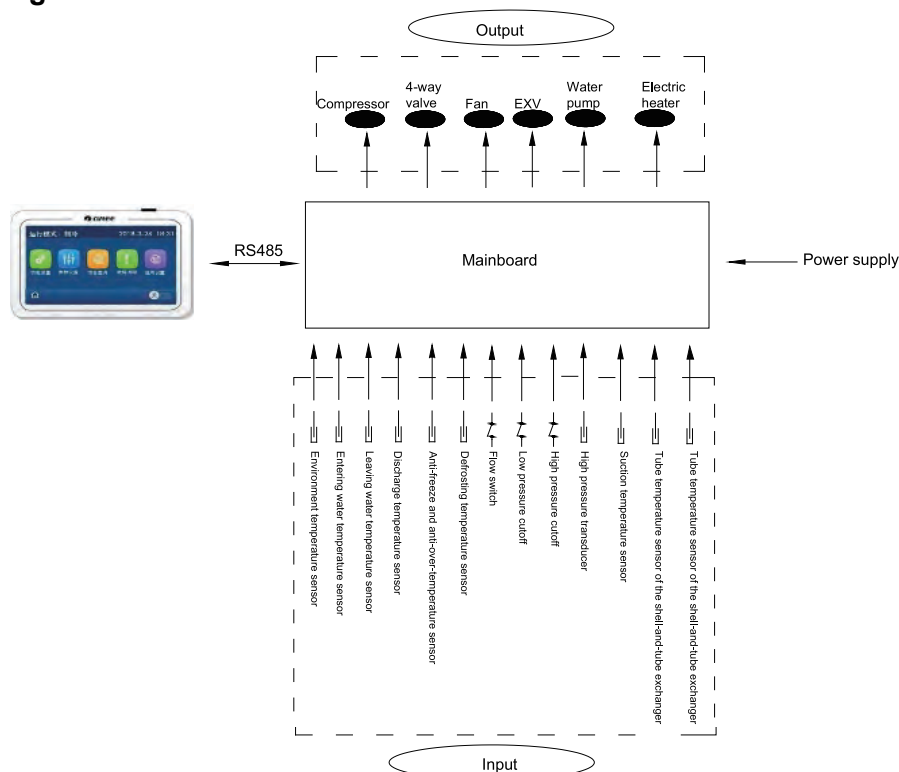

Description:

- (1) A water flow cutout is used to judge the water flow rate. When the flow rate is too low, it will trip off, and the control board will send this signal to the display and the water pump. Then, the display will tell there is an error, the water pump will stop and the unit will stop or will not start.
- (2) A high/low pressure cutout is used to judge the system pressure. When the system pressure is too high/low, it will trip off, and the control board will send this signal to the display. Then, the display will tell there is an error and the unit will stop or will not start.
- (3) An ambient temperature sensor is used to detect the temperature of the environment where the unit is which will determine whether to start or stop the fan and determine the steps of the electrostatic expansion valve when initializing. When this sensor fails, the control board will detect and send this signal to the display. Then, the display will tell there is an error and the unit will stop or will not start.
- (4) A discharge temperature sensor is used to detect the discharge temperature. When the sensed temperature is too high or this sensor fails, the control board will detect and send this signal to the display. Then, the display will tell there is an error and the unit will stop or will not start.
- (5) An entering water temperature sensor is used to detect the temperature of the entering water which will determine whether to start or stop the compressor and the auxiliary electric heater. When this sensor fails, all compressors of the unit will stop.
- (6) Defrost temperature sensor is used to detect the liquid tube temperature of fins serving the condenser, which will determine whether to start the fan. When the sensed temperature is too high or this sensor fails, the control board will detect and send this signal to the display. Then, the display will tell there is an error and the unit will stop or will not start.

- (7) An anti-freezing and overheating prevention temperature sensor is used to detect the water temperature. When it fails, compressors and fans of the corresponding unit will stop.
- (8) A leaving water temperature sensor is used to detect the leaving water temperature. When this sensor fails, compressors and fans of the corresponding unit will stop.
- (9) An air temperature sensor on shell-and-tube heat exchanger is used to detect the air temperature. When this sensor fails, the compressor in a cooling state will have to be stopped and the display will tell there is an error. If the sensor fails in a heating state, only the display will tell an error.
- (10) A liquid temperature sensor on shell-and-tube heat exchanger is used to detect the liquid temperature. When this sensor fails, the compressor in a cooling state will have to be stopped and the display will tell there is an error. If the sensor fails in a heating state, only the display will tell an error.
- (11) A suction temperature sensor is used to detect the suction temperature. When this sensor fails, the compressor in a cooling state will have to be stopped and the display will tell there is an error. If the sensor fails in a heating state, only the display will tell an error.
- (12) High-pressure sensor is used to detect the discharge pressure. When the sensed temperature is too high, control the compressor to regulate the frequency of discharge.

4.2 Operation Flowchart

4.2.1 Cooling

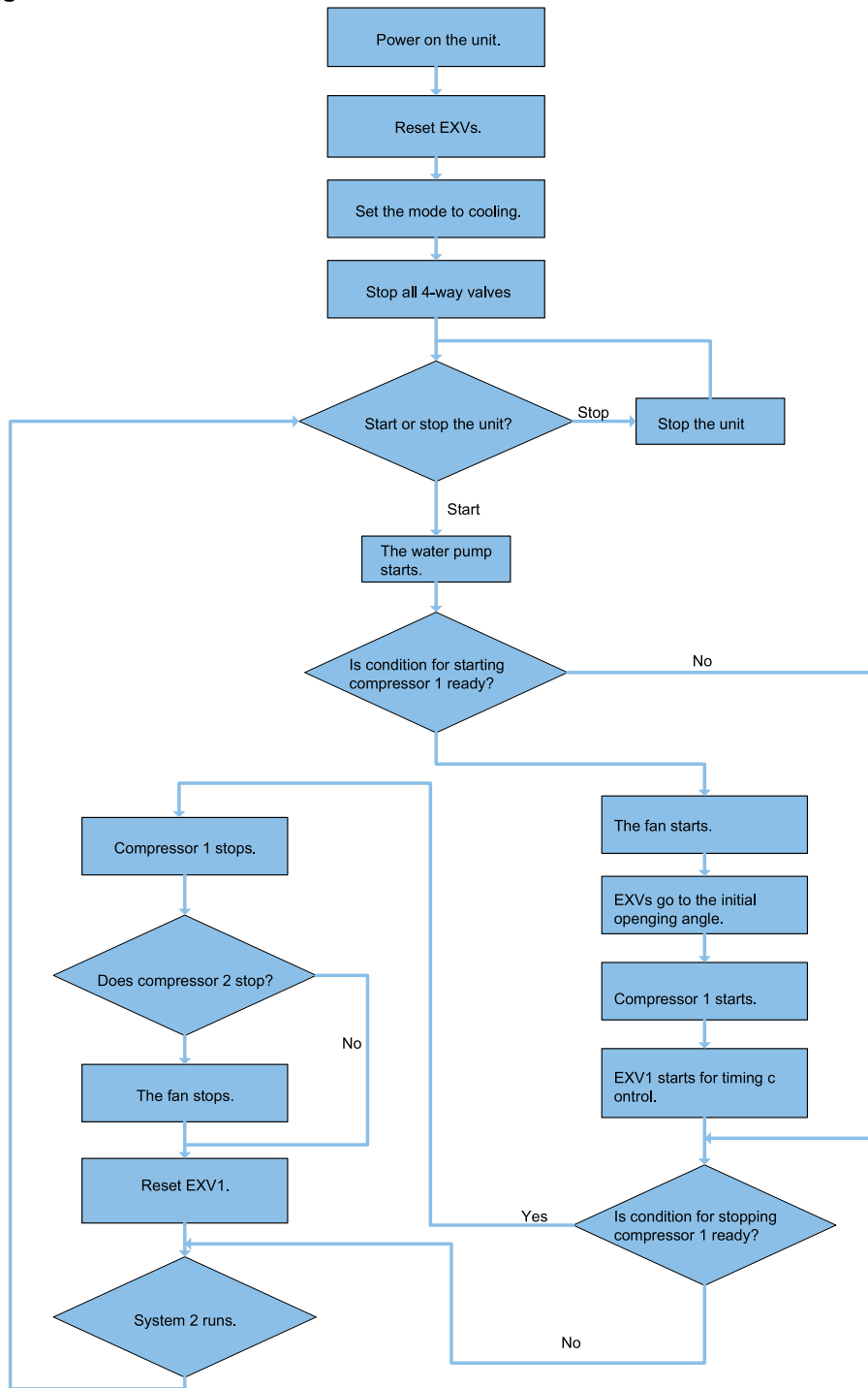

4.2.2 Heating

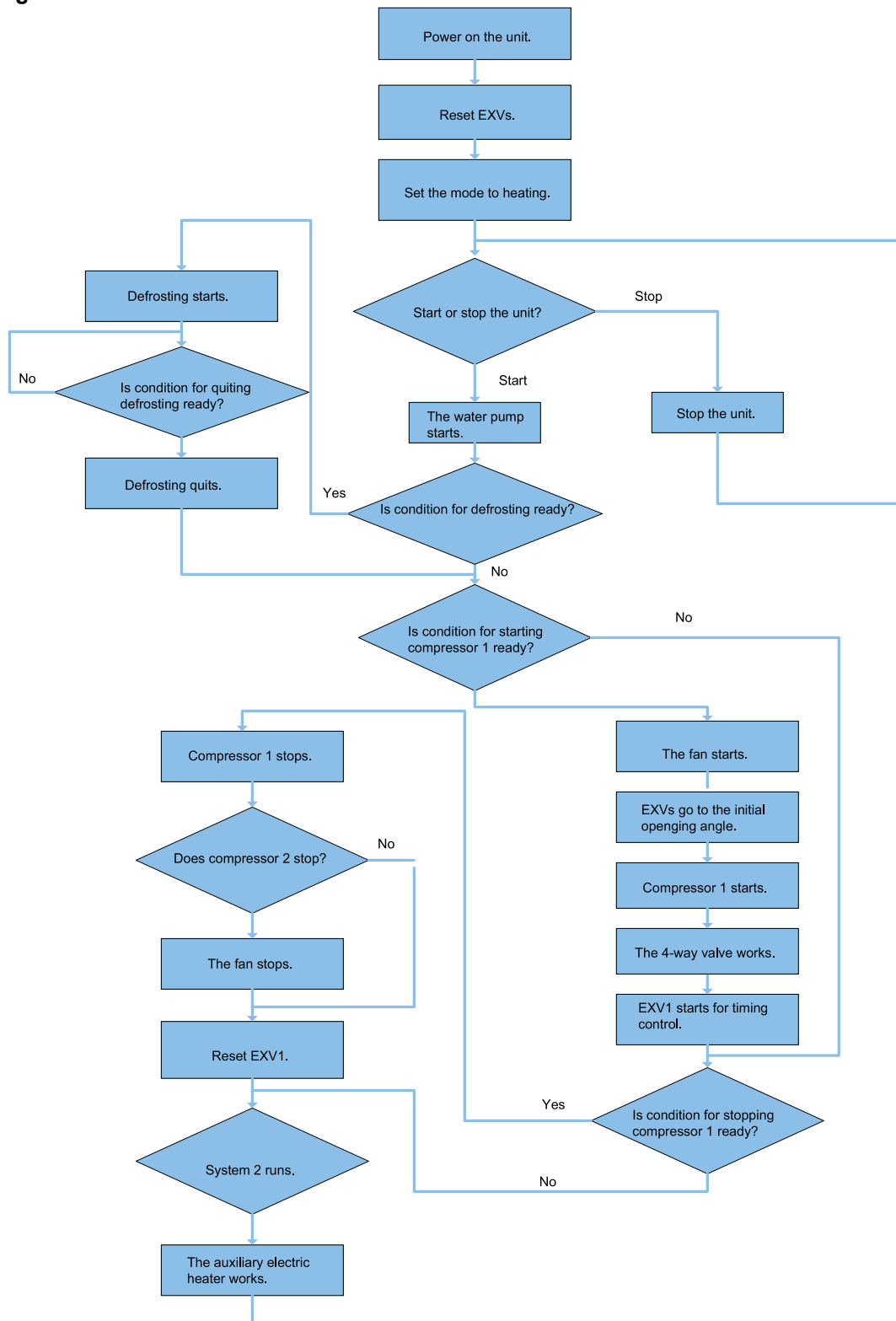

4.3 Key Control Logics

4.3.1 Cooling Control

4.3.1.1 Freeze-up Protection

For each single unit, when the anti-freezing temperature or the leaving water temperature is lower than the limit value, freeze protection will work; when the anti-freezing temperature and the leaving water temperature go higher than the normal value, freeze protection will quit.

when the anti-freezing temperature and the leaving water temperature are between the limit value and the normal value, the unit will keep the current operation status.

4.3.1.2 Shutdown

Manual and timely shutdown: compressors, fans and then water pumps will stop.

Shutdown at the set temperature: compressors and fans will stop but water pumps will still be working.

Shutdown due to malfunction: compressors and fans will stop but water pumps will still be working.

4.3.2 Heating Control

4.3.2.1 Over-temperature Protection for Heating

For each single unit, when either anti-over-temperature value or the leaving water temperature goes higher than the targeted value, over-temperature protection will work and the operation frequency of the compressors will be lowered until the anti-over-temperature value or the leaving water temperature is lower than the targeted level. Stop compressors one by one, if the operation frequency has been recorded the lowest and either the anti-over-temperature value or the leaving temperature remains above the targeted level for 1 minute.

With the anti-over-temperature value or the leaving water temperature below the normal level, overheating protection will quit. If it occurs with a reduced frequency, the compressor should be controlled by the water temperatures for working as normal.

4.3.2.2 Control to the Auxiliary Electric Heater

When the control function of the auxiliary electric heater has been activated through the control panel, the unit is able control the auxiliary electric heater.

The auxiliary electric heater is able to work automatically as long as there is no fault of the flow switch and all entering and leaving water temperature sensors work normally.

When the control function of the auxiliary electric heater has been activated through the control panel, the auxiliary electric heater will not work any more.

When all entering and leaving water temperature sensors are faulty, the auxiliary electric heater will stop working.

When any flow switch fails, the auxiliary electric heater will stop working.

When over-temperature protection for heating works but the auxiliary electric heater is still required for operation, it will work continuously when its heating task is finished.

4.3.2.3 Shutdown

Manual or timing shutdown: compressor stops firstly, and the auxiliary electric heater second, and then the fan and water pump.

Shutdown upon the temperature set point: the compressor and the fan stop firstly, while the water pump keeps running.

Shutdown upon errors: the compressor stops firstly and the fan, while the water pump keeps running.

4.3.3 Automatic Anti-freezing Operation

For each single unit, when the anti-freezing temperature or the leaving water temperature is lower than the limit value, freeze protection will work; when the anti-freezing temperature and the leaving water temperature go higher than the normal value, freeze protection will quit.

when the anti-freezing temperature and the leaving water temperature are between the limit value and the normal value, the unit will keep the current operation status.

4.3.4 Control to the Compressor

1)“First On, First Off”

“First On, First Off”/ “First Off, First On” control indicates the numbered compressor which is started/stopped firstly will then be stopped/started firstly.

4.3.5 Control to the Fan

The fan will start when the unit is turned on and will stop when the compressor is turned off. During defrosting, the fan does now work but will back to working when defrosting exists.

4.3.6 Control to the 4-way Valve

At the cooling mode, the 4-way valve will not work when the unit goes for defrosting or the unit is OFF. At the heating mode, the 4-way valve will work when the unit is turned on or defrosting quits.

4.3.7 Control to the Water Pump

When there is demand for any single unit, the water pump will start. When there is no demand for all water pumps, the water pump will stop.

4.3.8 Control to the Electronic Expansion Valve

The electronic expansion valve will be initialized when the controller is powered on for the first time.

After the compressor has been started, the electronic expansion valve starts to adjust its opening angle

4.3.9 Protection

4.3.9.1 Recoverable Protection

(1) Fault of Communication

The unit will stop when it receives no signal from the controller. Once there is any communication fault for any unit, all compressors of this unit will stop and then the water pump will follow.

4.3.9.2 Irrecoverable Protection

(1) Protection against High Pressure for the Compressor 1/2

When it is detected that the high pressure cutoff of the compressor 1/2 is tripped off, compressor 1/2 will stop immediately. If both compressors are closed, their fans will be delayed to stop. In this case, the control panel will display an alarm symbol, which should be cleared manually for resuming normal operation.

(2) Protection for the Flow Switch

When it is detected for some unit that the flow switch is opened, this unit will stop. When protection for the flow switch occurs for all unit, all compressors and water pumps will stop.

(3) Fault of Communication

When a single unit does not receive any signal from the controller, this unit will stop automatically. For the unit with communication fault, when all its compressors stop and then the water pump will follow.

(4) Protection against Phase Loss/Reversal

When there is phase loss or reversal for power supply, power for the main board will be cut off directly. In this case, there is nothing for the main board.

(5) Protection for Abnormal 4-way Valve

When it is detected that the entering water temperature is 4°C higher than the leaving water temperature and the leaving water temperature continuously goes down, the control panel will display this fault.

4.4 General Introduction



It uses the capacitor type touch screen for information input. The effective area for touching indicates the rectangular black area when the backlight of the control panel lights off.

As the flexibility of the control panel is quite high, it would make an accidental response when there is foreign matter on the surface of the control panel. Therefore, please keep the both the touch screen and the finger clean during operation. Also, please keep the control panel far away from the source of high-intensity electromagnetic interference.

Note: the function for the press button at the upper right corner is reserved and there will no response to this operation. This picture as shown above is just for reference

4.4.1 Homepage



Figure 4-1 Homepage

No	Introduction
1	Unit name, error icon and name, BMS alert
2	Year, month, day, hour, and minute
3	Quantity of the on-line units
4	ON/OFF mode
5	Temperature set point under the corresponding control mode
6	Menu icon
7	Run mode setting
8	On/Off key. When "Contact ON/OFF" or ON/OFF timer has been activated, ON/OFF status will change with the actual status of the unit.

(1) It is defaulted to keep at the homepage.

(2) Touching the menu icon is able to access to the menu page.

(3) Generally the unit name is displayed at the left upper corner of the control panel. If there is BMS communication, the BMS alert "**Remote Control:On**" and the unit name will be displayed circularly in five minutes.

(4) Generally the unit name is displayed at the left upper corner of the control panel. If there are errors, their icons and names will be displayed circularly (one time every second) instead



[Notes]

When there is no any operation in ten minutes at any page, except the warning pages as shown in the figure below, it will automatically back to the homepage.

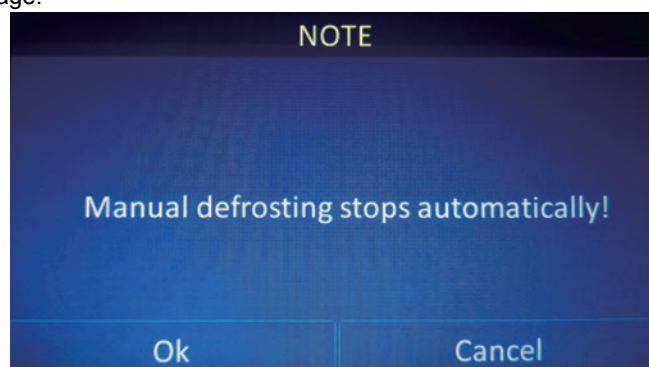

4.4.2 Menu Page



Figure 4-2 Menu Page

No	Item	Interpretation
1	FUNCTION	It is used to access to the function setting pages.
2	PARA.	It is used to access to the parameter setting pages.
3	INFO	It is used to access to the information viewing pages.
4	E-CLEAR	It is used to access to the error clearing and "Unlock discharge failure" page.
5	GENERAL	It is used to access to the general setting pages.
6	Homepage icon	It is used to go back to the homepage.
7	ON/OFF key	On/Off key. When "Contact ON/OFF" or ON/OFF timer has been activated, ON/OFF status will change with the actual status of the unit.

- (1) The unit status will be displayed at the left upper corner of the control panel.
- (2) Generally the unit name is displayed at the left upper corner of the control panel. If there is BMS communication, the BMS alert "**Remote Control:On**" and the unit name will be displayed circularly in five minutes.
- (3) Generally the unit name is displayed at the left upper corner of the control panel. If there are errors, their icons and names will be displayed circularly (one time every second) instead.

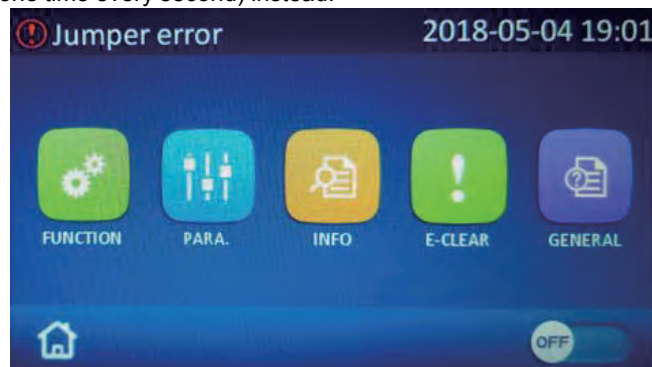

4.4.3 Introduction to the Pop-up Windows

When any operation fails or is incorrect, a window will pop up

- (1) When this is any pop-up window, except touching "**OK**", any other touching is ineffective. Then, the pop-up window would disappear and normal operation to the control panel resumes.
- (2) When it is detected that there is no any operation in ten seconds after a window pops up, it will disappear and normal operation to the control panel resumes.

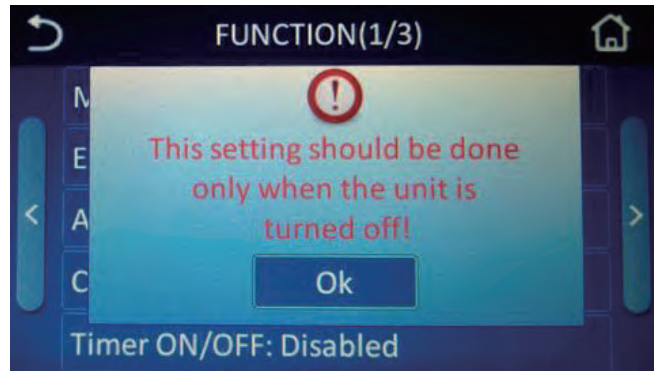

4.4.4 Backlight

When it is deactivated, the control panel will automatically light off 5 minutes later after there is no any operation to the control panel. Any touching to the effective area will again light on the control panel.

When this function is activated, the control panel will be lighted on always.

It is suggested to deactivate it to extend the service life.

4.5 Operation Instructions

For functions unavailable for this unit, "N/A" will be displayed or they cannot be set during operation.

4.5.1 On/Off

Operation Instructions

(1)At the homepage and menu page when the unit is "OFF", by touching "ON/OFF", the control panel will access to the following page.

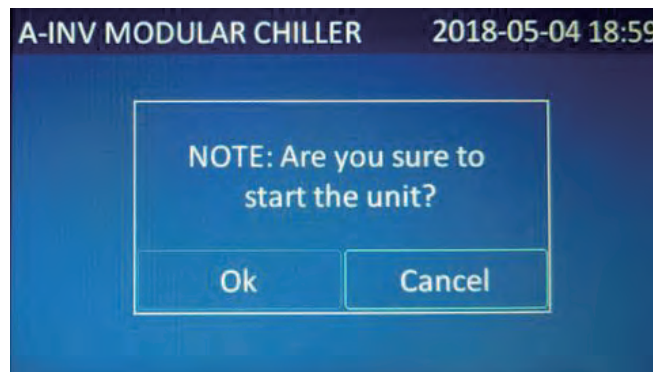

(2)Press "OK" and then the control panel will access to the following "ON" page.

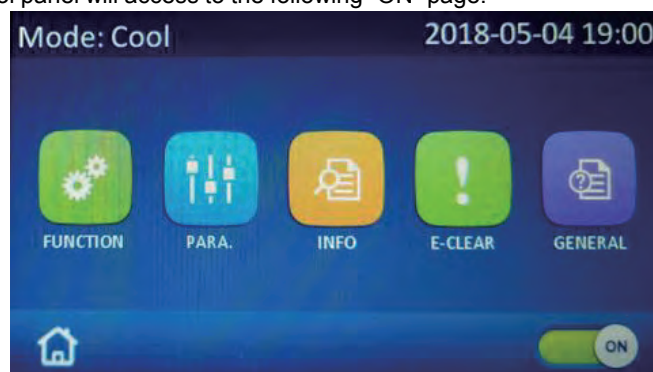

(3) At the homepage and menu page when the unit is "ON", by touching "ON/OFF", the control panel will access to the following page.

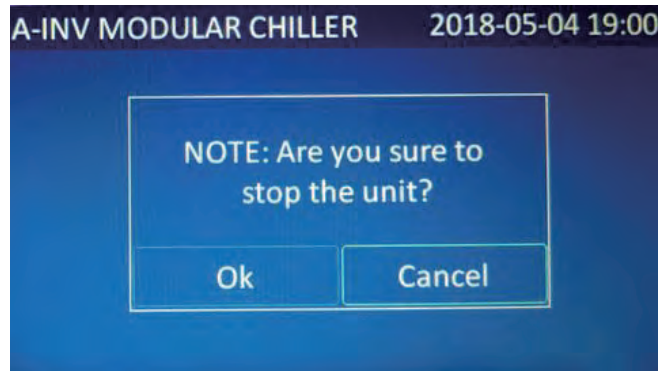

(4) Press "OK" and then the control panel will access to the following "OFF" page.



[Notes]

Upon first power-on, the On/Off status will not be memorized. However, once "ON/OFF memory" is set to "ON" at the function setting page the On/Off status will be memorized upon next power-on. When "ON/OFF memory" is set to "No", the control panel will keep OFF status upon next each power-on, as shown in the figure above.

4.5.2 Functions

Operation Instructions

(1)At the menu page, it will go to the parameter setting page by touching“FUNCTION”, as shown in the figure below.

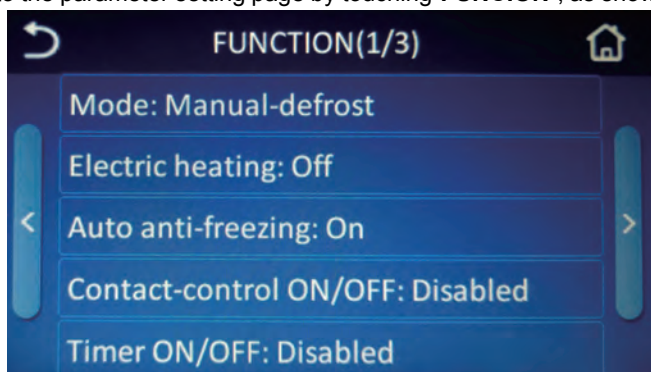

Figure 4-3 Function Page 1

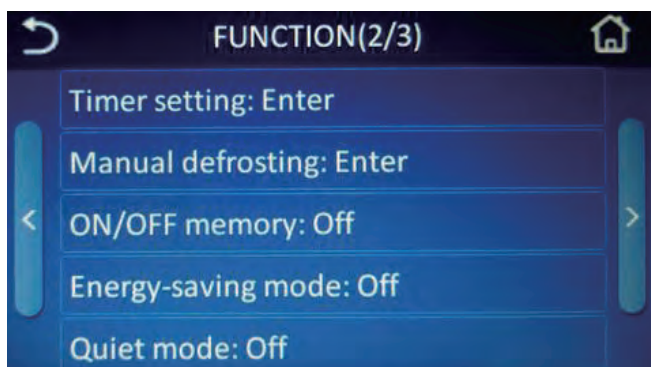

Figure 4-4 Function Page 2

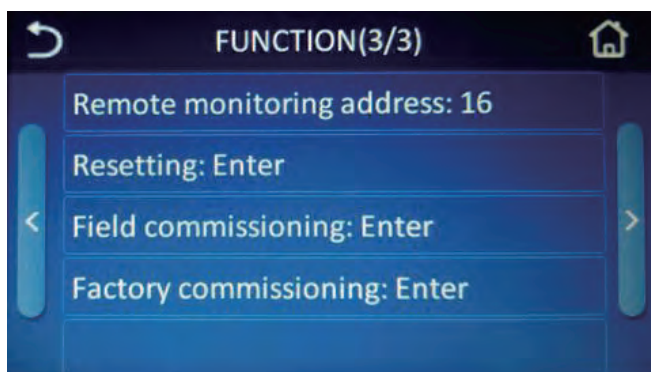

Figure 4-5 Function Page 3

(2)At the function setting page, the last page or next page icon allows the control panel accessing to the last or next function page; the homepage icon allows going back to the homepage; and the back icon allows to the super-menu page.

(3)At the function setting page, touching the desired function option will access to the corresponding function setting page.

(4)At the desired function setting page, touching“OK” will save the setting and touching“Cancel” will exit this setting. Meanwhile the control panel will back to the function setting page under both conditions.

[Notes]

1)When there is submenu for the desired function option, by touching it, the control panel will access to the sub-menu setting page.

2)At the setting page, press “OK” finish and save this setting. However, in this case, there will be no alert message.

3)At the function setting page, when any function status is changed and memorized, it will resume the changed status upon next power-on.

See the table below for more details about each function.

No	Parameter Name	Range	Interpretation
1	Mode	Manual-defrost; Heat; Cool	It can be set under the OFF status.
2	Electric heating	Off; On	It is unavailable for the cooling only unit.
3	Auto anti-freezing	Off; On	/
4	Contact-control ON/OFF	Disabled; Enabled	/

5	Timer ON/OFF	Disabled; Enabled	It allows the unit to be timed on or off.
6	Timer setting	Enter	It is used to set the timer.
7	Manual defrosting	Enter	It can be set when the unit is off and "Mode" is set to "Manual-defrost".
8	ON/OFF memory	Off; On	/
9	Energy-saving mode	Off; On	/
10	Quiet mode	Off; On	/
11	Remote monitoring address	1~255	/
12	Resetting	Enter	Except the language setting
13	Field commissioning	Enter	/
14	Factory commissioning	Enter	/

(1) Mode

Operation Instructions

At the function setting page, when the unit is OFF, by touching "Mode", the control panel will go to the corresponding setting page. Then, select the desired option. After that, by touching "OK", this setting will be saved and the control panel will go back to the function setting page; or by touching "Cancel" this setting will not be saved and directly go back to the function setting page.

[Notes]

- 1) For the cooling only unit, only "Cool" is available.
- 2) When it is set to "Manual-defrost", it will access to the corresponding setting page. Then, see Section for more details.
- 3) It can be memorized upon power failure.

(2) Electric Heating

Operation Instructions

At the function setting page, by touching "Electric heating", the control panel will go to the corresponding setting page. Then, select the desired option. After that, by touching "OK", this setting will be saved and the control panel will go back to the function setting page; or by touching "Cancel" this setting will not be saved and directly go back to the function setting page.

[Notes]

- 1) It is defaulted to be "Off" upon first power-on
- 2) This function is unavailable for the cooling only unit.
- 3) It can be memorized upon power failure.

(3) Auto anti-freezing

Operation Instructions

At the function setting page, by touching "Auto anti-freezing", the control panel will go to the corresponding setting page. Then, select the desired option. After that, by touching "OK", this setting will be saved and the control panel will go back to the function setting page; or by touching "Cancel" this setting will not be saved and directly go back to the function setting page.

[Notes]

- 1) It is defaulted to be "On" upon first power-on
- 2) It can be memorized upon power failure.

(4) Contact-control ON/OFF

Operation Instructions

At the function setting page, by touching "Contact-control ON/OFF", the control panel will go to the corresponding setting page. Then, select the desired option. After that, by touching "OK", this setting will be saved and the control panel will go back to the function setting page; or by touching "Cancel" this setting will not be saved and directly go back to the function setting page.

[Notes]

- 1) It is defaulted to be "Off" upon first power-on

2) It can be memorized upon power failure.

(5)Timer ON/OFF

Operation Instructions

At the function setting page, by touching “**Timer ON/OFF**”, the control panel will go to the corresponding setting page. Then, select the desired option. After that, by touching “**OK**”, this setting will be saved and the control panel will go back to the function setting page; or by touching “**Cancel**” this setting will not be saved and directly go back to the function setting page.

[Notes]

- 1) It is defaulted to be “Off” upon first power-on.
- 2) When “Contact-control ON/OFF” has been activated, “Timer ON/OFF” will be automatically be deactivated.
- 3) When it has been activated, it will access to the “Timer setting” page. Please see Section 2.2.6 for more details.
- 4) It can be memorized upon power failure.

(6)Timer Setting

Operation Instructions

1) At the function setting page, by touching “**Timer setting**”, the control panel will go to the corresponding setting page, as shown in the figure below.

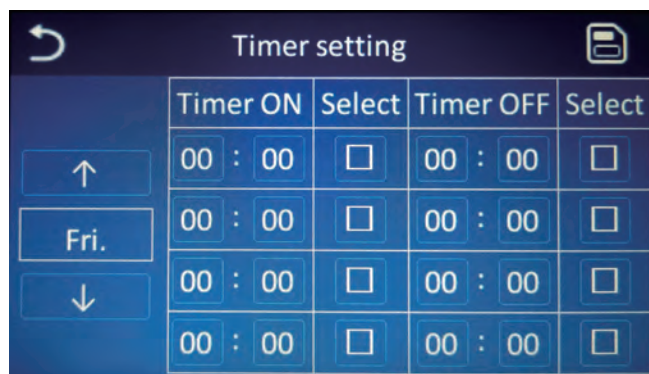

- 2) Select the week day from Monday to Sunday by the “↑” and “↓” keys.
- 3) There are four time periods for each week day. Each time period can be set to ON or OFF.
- 4) Touch the desired time point and input the hour and minute (as shown in the figure below).

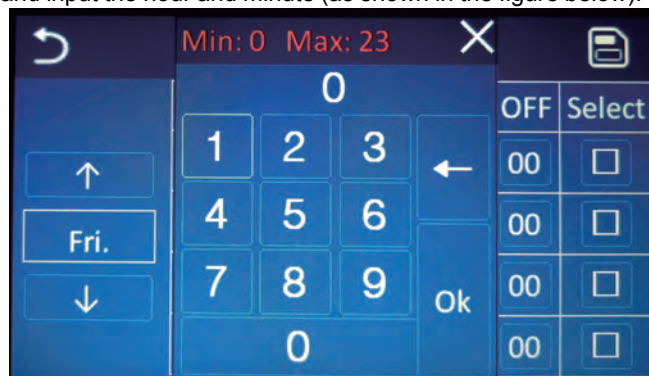

5) Then, touch “” under “**Select**” to make it turn to “√”, which then indicates the corresponding period has been invalidated.

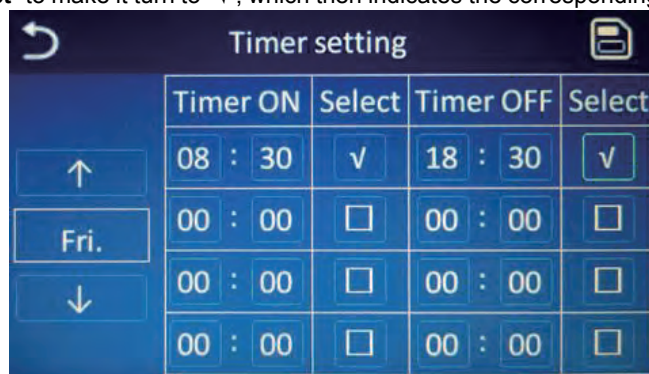

6) After that, press the saving icon at the upper right corner to save this setting, or press the back icon at the upper left corner to give up this setting.

(7) Manual Defrosting

Operation Instructions

- 1) At the function setting page, by touching **"Manual-defrost"**, the control panel will access to the page as shown below.

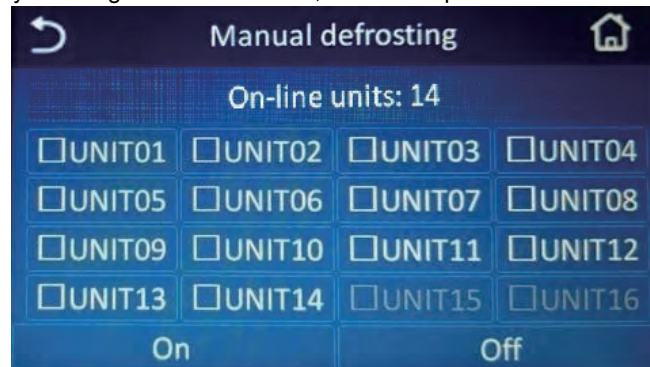

- 2) Select the unit in need of defrosting. Once **"□"** turns green, it indicates this unit has been selected. Two or more units cannot be selected at the same time.

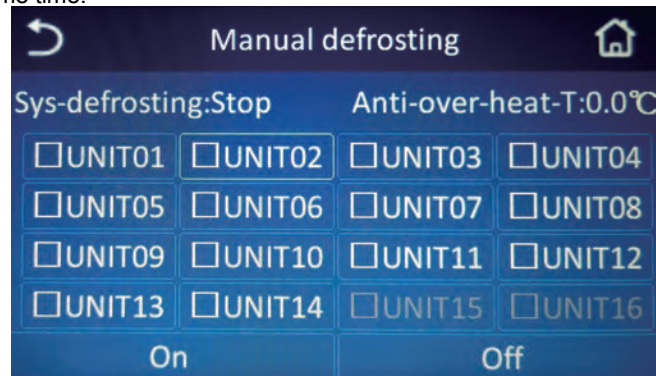

- 3) Enable the defrosting function of the selected unit. When **"□"** turns to **"√"**, it indicates manual defrosting function for this unit has started as shown in the figure below.

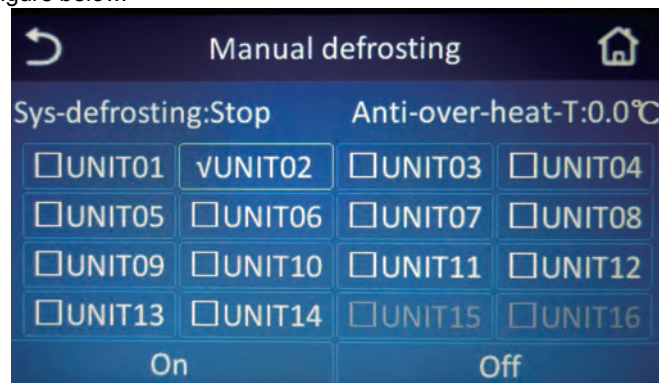

- 4) When disable the defrosting function for this unit, there will be a pop-up window, saying, **"Unit XX defrosting has not finished, are you sure to stop it manually?"** as shown in the figure below.

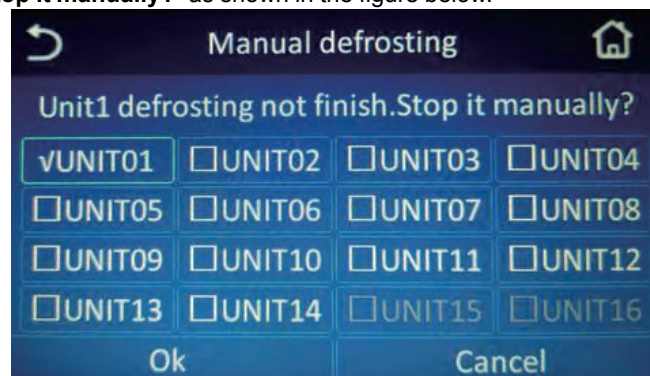

- 5) By pressing **"OK"**, manual defrosting will be deactivated, with **"√"** changed to **"□"**

[Notes]

- 1) Before activating this function, **"Mode"** should be firstly set to **"Manual-defrost"**.

- 2) At the unit selection page, the on-line units are in white color and those off-line are in grey.
- 3) This function setting is unavailable to the off-line units.

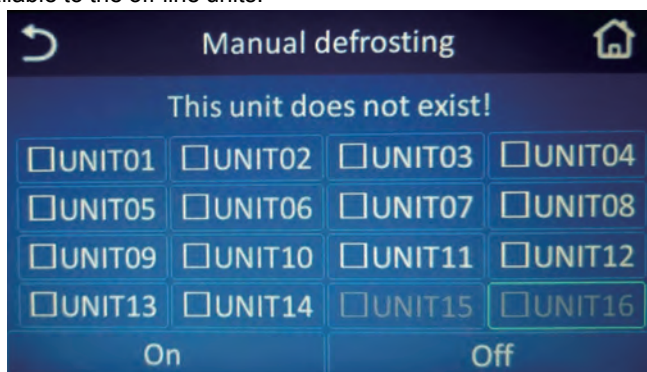

- 4) Do not activate this function for two or more units.

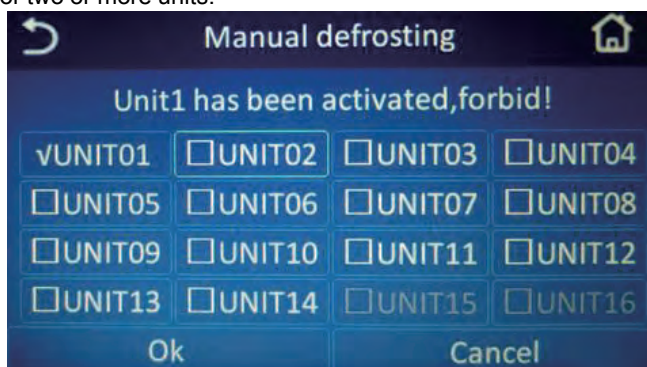

- 5) When this function has been enabled for five minutes, however the unit fails to perform defrosting. Then, this function will be disabled, also warning **“Manual defrosting stops automatically!”**
- 6) When this function has been enabled, however actual defrosting will be delayed for some time.

(8) ON/OFF Memory

Operation Instructions

At the function setting page, by touching **“ON/OFF memory”**, the control panel will go to the corresponding setting page. Then, by touching **“OK”**, default parameters will be put into use; or by touching **“Cancel”** the control panel will go back to the function setting page; or by touching **“Cancel”** this setting will not be saved and directly go back to the function setting page.

(9) Energy-saving mode

Operation Instructions

At the function setting page, by touching **“Energy-saving mode”**, the control panel will go to the corresponding setting page, where it can be set to be **“On”** or **“Off”**. Then, by touching **“OK”**, default parameters will be put into use; or by touching **“Cancel”** the control panel will go back to the function setting page; or by touching **“Cancel”** this setting will not be saved and directly go back to the function setting page.

(10) Quiet Mode

Operation Instructions

- 1) At the function setting page, by touching **“Quiet mode”**, the control panel will go to the corresponding setting page, where it can be set to be **“On”** or **“Off”**. Then, by touching **“OK”**, default parameters will be put into use; or by touching **“Cancel”** the control panel will go back to the function setting page; or by touching **“Cancel”** this setting will not be saved and directly go back to the function setting page.

(11) Remote Monitoring Address

Operation Instructions

At the function setting page, by touching **“Resetting”**, the control panel will go to the corresponding setting page, as shown

below. Then, by touching “Yes”, default parameters will be put into use; or by touching “No” / “Cancel”, the control panel will go back to the function setting page.

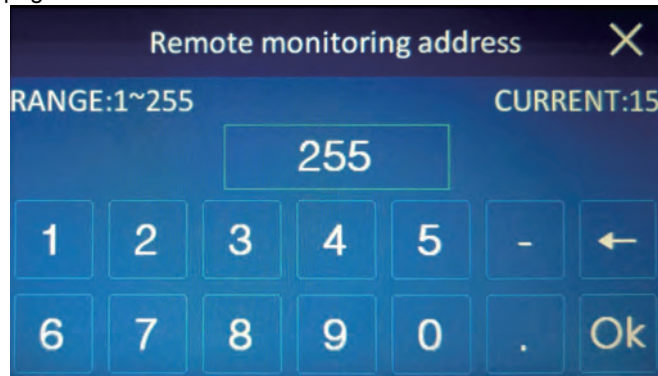

(12)Resetting

Operation Instructions

At the function setting page, by touching “Resetting”, the control panel will go to the corresponding setting page, as shown below. Then, by touching “Yes”, default parameters will be put into use; or by touching “No” / “Cancel”, the control panel will go back to the function setting page.

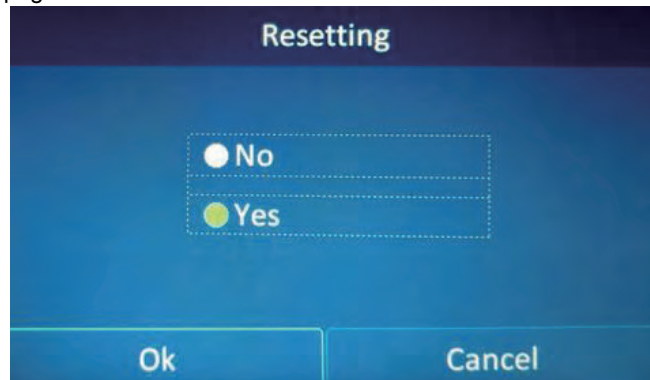

[Notes]

- 1) After this setting, all parameters at the user parameter setting page will go back to the default setting.
- 2) After this setting, except clock timer and language at the “General” setting page, all will go back to the default setting.
- 3) After this setting, all parameters at the parameter setting page except “Timer setting” and “Manual defrost” will go back to the default setting.
- 4) It will not function on “Field commissioning” and “Factory commissioning”.

(13)Field Commissioning

Operation Instructions

At the function setting page, by touching “Field commissioning”, the control panel will go to the password input page. Then, by entering correct passwords, it will access to the “Field commissioning” page, where is used mainly for system parameter setting for repair and maintenance.

[Notes]

Arbitrary change to “**field commissioning**” will bring series adverse effect to the unit. Therefore, no one is allowed to do this except the approved qualified servicemen

(14)Factory Commissioning

Operation Instructions

At the function setting page, by touching “Factory commissioning”, the control panel will go to the password input page. Then, by entering correct passwords, it will access to the “Factory commissioning” page, which is used mainly for repair and maintenance by after-sales servicemen.

[Notes]

Arbitrary change to “Factory commissioning” will bring series adverse effect to the unit. Therefore, no one is allowed to do this except the approved qualified servicemen. !

4.5.3 Parameter

Operation Instructions

(1)At the menu page, by touching “**PARAMTER**”, the controller will access to the parameter setting page, as shown in the figure below.

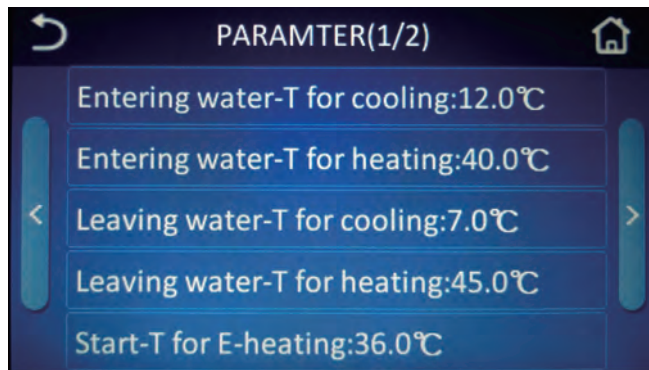

Figure 4-6 Parameter Setting Page 1

(2)At the parameter setting page, by touching the last page and next page icons, the desired setting page can be selected.

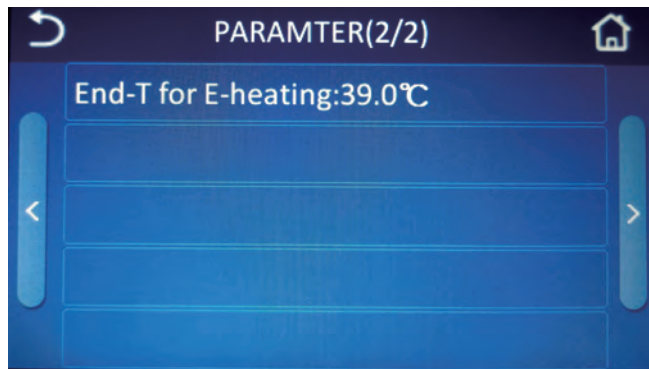
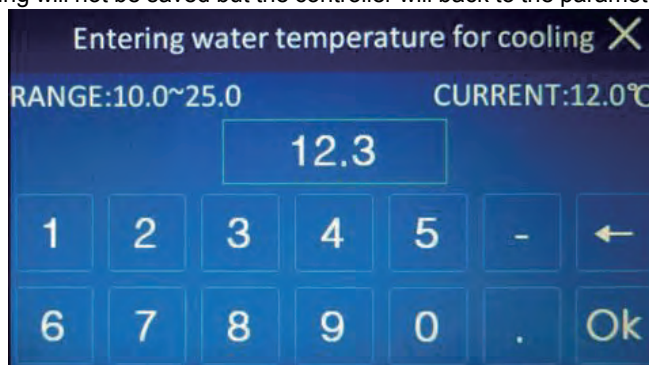

Figure 4-7 Parameter Setting Page 2

(3)By touching the desired parameter, the controller will access to the corresponding setting pages as shown in the figure below. After that, by touching “**OK**”, this setting will be saved and the controller will back to the parameter setting page; while by touching “**Cancel**”, this setting will not be saved but the controller will back to the parameter setting page.



[Notes]

- 1)For the parameters with different defaults under different conditions, when the constraint (like, unit type) changes, the parameter will back to the default value under the corresponding condition.
- 2)When setting for the current parameter is unavailable, “**N/A**” will be displayed.
- 3)The numerical keypad includes digits from “**0~9**”, “**-**”, “**.**”, “**OK**” and the backspace key.
- 4)When the input value is out of the setting range or accuracy of the input value is inconsistent with that of the rated, continuous input will fail or there will be corresponding alert, and also the input value will be automatically deleted.

See the table below for the user parameters.

No	Full Name	Displayed Name
1	Entering water temperature for cooling	Entering water-T for cooling
2	Entering water temperature for heating	Entering water-T for heating
3	Leaving water temperature for cooling	Leaving water-T for cooling
4	Leaving water temperature for heating	Leaving water-T for heating
5	Start temperature for E-heating	Start-T for E-heating
6	End temperature for E-heating	End-T for E-heating

4.5.4 Information

Operation Instructions

(1)At the menu page, by touching “**INFO.**”, the control panel will go to the following page.



(2)At the above page, by selecting the desired unit, the control panel will go to the following page.

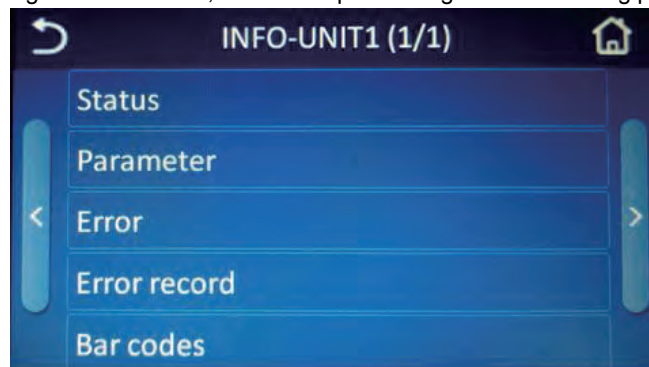

Notes

1)It is only available for the on-line units, namely those in white.

2)When there is some error, the corresponding unit will be in red and there will a red point at its upper right corner.

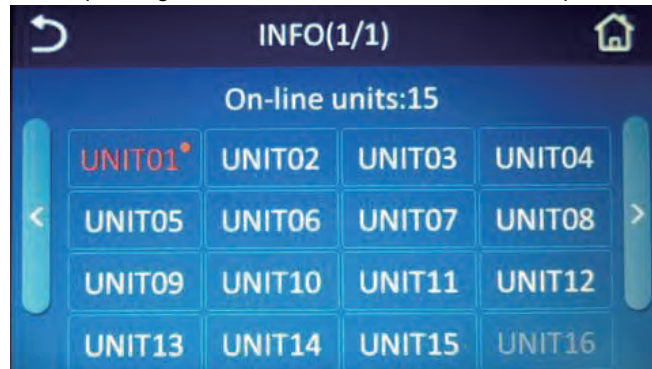

Figure 4-8 Unit in Red

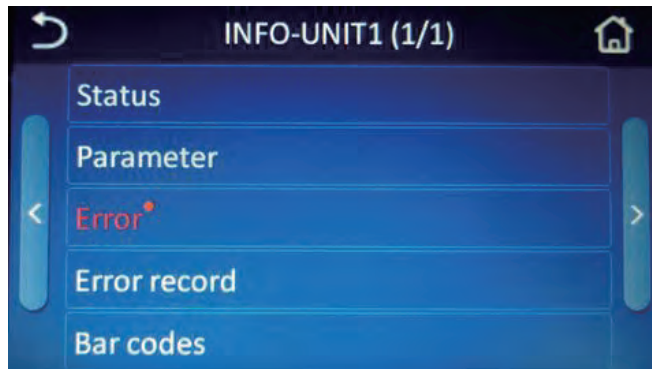

Figure 4-9 Unit with a Red Point

(1)Status

Operation Instructions

By touching“**Status**”, the control panel will go to the stats pages, where it is able to check the running status of the unit.

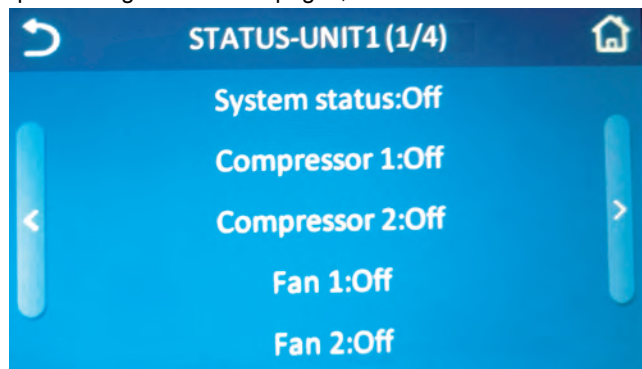

Figure 4-10 Status Page 1

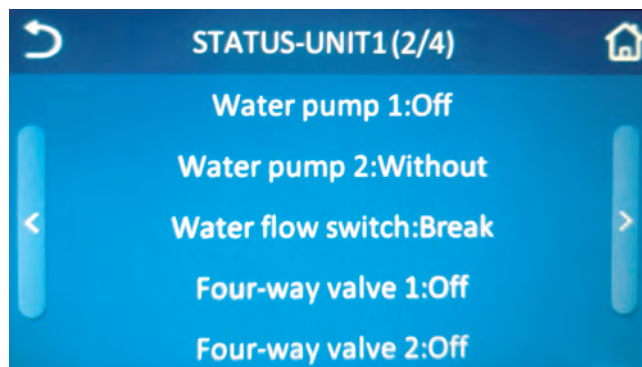

Figure 4-11 Status Page 2

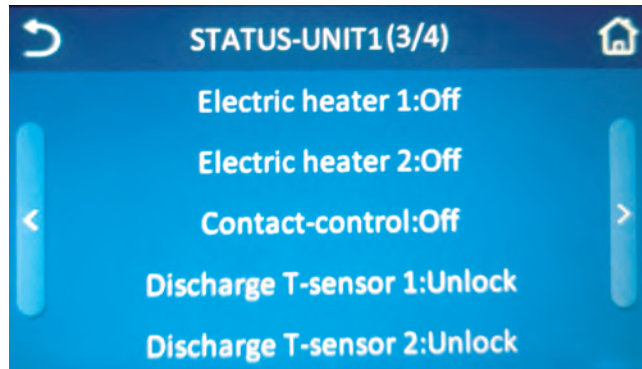

Figure 4-12 Status Page 3

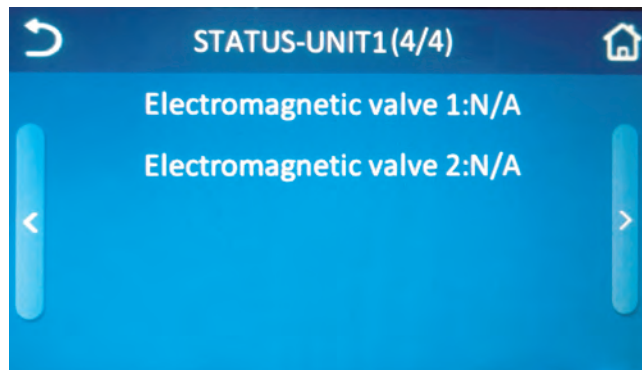

Figure 4-13 Status Page 4

No	Name	Status	No	Name	Status
1	System status	Off; Cooling; Heating; Defrosting; Automatic antifreeze	10	Four-way valve 2	On; Off
2	Compressor 1	On; Off	11	Electric heater 1	On; Off
3	Compressor 2	On; Off	12	Electric heater 2	On; Off
4	Fan 1	On; Off	13	Contact-control	On; Off
5	Fan 2	On; Off	14	Discharge T-sensor 1	Unlock/Lock
6	Water pump 1	On; Off	15	Discharge T-sensor 2	Unlock/Lock
7	Water pump 2	On; Off; Without	16	Electromagnetic valve 1	On; Off
8	Water flow switch	On; Off	17	Electromagnetic valve 2	On; Off
9	Four-way valve 1	On; Off			

Notes

“N/A” will be displayed for the status which is unavailable for the corresponding unit.

When “**Alternation function**” is set to “**Off**”, “**Water pump 2**” will be defaulted to be “**Without**”.

(2)Parameter

Operation Instructions

By touching “**Parameter**”, the controller will access to the parameter checking page.

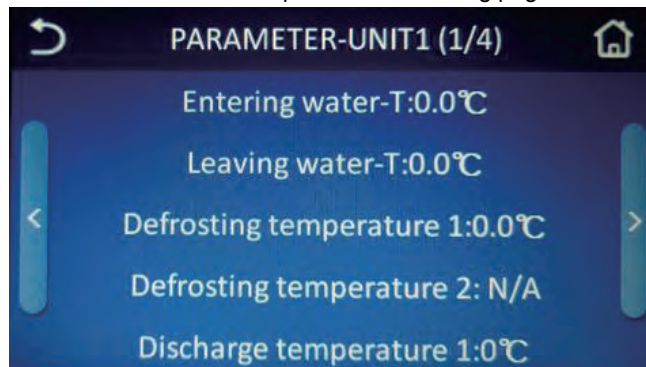

Figure 4-14 Parameter Page 1

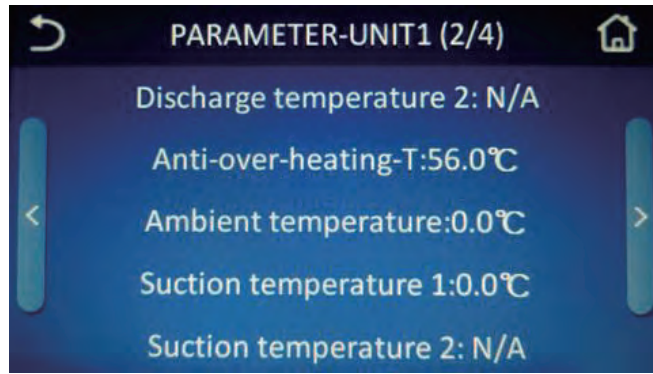

Figure 4-15 Parameter Page 2

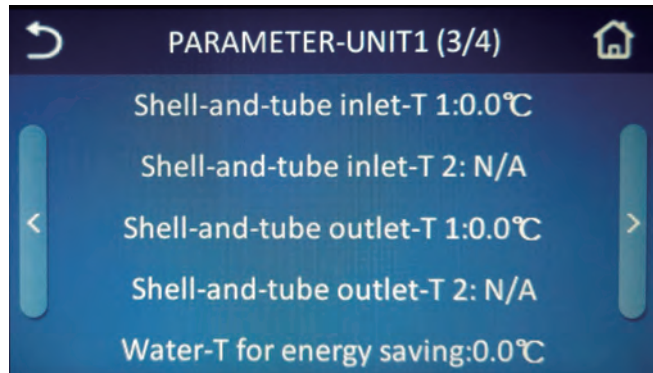

Figure 4-16 Parameter Page 3

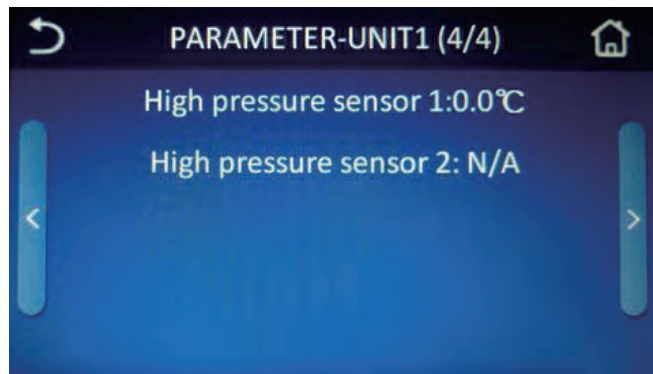

Figure 4-17 Parameter Page 4

No	Name	No	Name
1	Entering water-T	10	Suction temperature 1
2	Leaving water-T	11	Suction temperature 2
3	Defrosting temperature 1	12	Shell-and-tube inlet-T 1
4	Defrosting temperature 2	13	Shell-and-tube inlet-T 2
5	Discharge temperature 1	14	Shell-and-tube outlet-T 1
6	Discharge temperature 2	15	Shell-and-tube outlet-T 2
7	Anti-freezing-T	16	Water-T for energy saving
8	Anti-over-heating-T	17	High pressure sensor 1
9	Ambient temperature	18	High pressure sensor 2

[Note]

1) "N/A" will be displayed when the temperature value for the corresponding mode or unit does not exist or is invalid.

2) For item 7 and 8 in the table above, when "Mode" is set to "Cool", only "Anti-freezing-T" will be displayed; when "Mode" is set to others, only "Anti-over-heating-T" will be displayed.

(3) Error

Operation Instruction

By touching "Error", the control will access to the error check page. When there is no any error, the control panel will show as below.

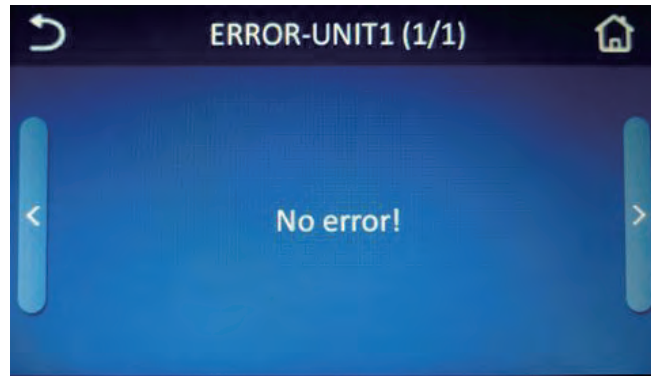

[Notes]

The controller can display real-time errors and all real-time errors can be displayed there.

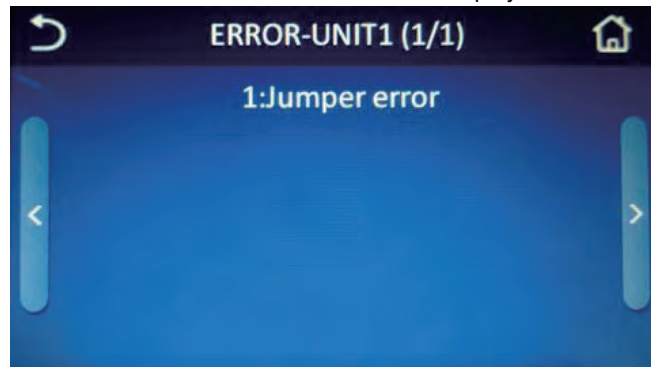

When the quantity of error exceeds 5, by touching the last or next page icon, the desired error can be checked.

See the table below for the error list.

No	Short Name	Full Name
1	Jumper error	Jumper error
2	Air-Con Water-FS	Air conditioning water flow switch error
3	Sys1 H-discharge-T	Protection against high discharge temperature of system 1
4	Sys2 H-discharge-T	Protection against high discharge temperature of system 2
5	Dis-TS1 malfunction	Discharge temperature sensor error of system 1
6	Dis-TS2 malfunction	Discharge temperature sensor error of system 2
7	Sys1 high pressure	Protection against high pressure of system 1
8	Sys2 high pressure	Protection against high pressure of system 2
9	Sys1 low pressure	Protection against low pressure of system 1
10	Sys2 low pressure	Protection against low pressure of system 2
11	Entering water TSE	Entering water temperature sensor error
12	Leaving water TSE	Leaving water temperature sensor error
13	Anti-F/anti-H TSE	Anti-freeze/anti-over-heating temperature sensor error
14	Ambient TSE	Ambient temperature sensor error
15	Defrosting TSE1	Defrosting temperature sensor of system 1
16	Defrosting TSE2	Defrosting temperature sensor of system 2
17	Discharge TSE1	Discharge temperature sensor error of system 1
18	Discharge TSE2	Discharge temperature sensor error of system 2
19	Shell&tube inlet TSE1	Shell-and-tube inlet temperature sensor error of system 1
20	Shell&tube inlet TSE2	Shell-and-tube inlet temperature sensor error of system 2
21	Suction TSE1	Suction temperature sensor error of system 1

A Series Modular-type Air-cooled (Heat Pump) Chiller

No	Short Name	Full Name
22	Suction TSE2	Suction temperature sensor error of system 2
23	Pressure TSE1	Pressure sensor error of system 1
24	Pressure TSE2	Pressure sensor error of system 2
25	Commu-E comp1	Communication error of the drive board of compressor 1
26	Commu-E comp2	Communication error of the drive board of compressor 2
27	Commu-E fan1	Communication error of the drive board of fan 1
28	Commu-E fan2	Communication error of the drive board of fan 2
29	Prote-4-way valve1	Protection against failure of four-way valve 1
30	Prote-4-way valve2	Protection against failure of four-way valve 2
31	Shell&tube outlet TSE1	Shell-and-tube outlet temperature sensor error of system 1
32	Shell&tube outlet TSE2	Shell-and-tube outlet temperature sensor error of system 2
33	Failure of pump1	Protection against failure of pump 1
34	Failure of pump2	Protection against failure of pump 2
35	Fan1 error	Fan 1 error
36	Fan2 error	Fan 2 error
37	DC under-voltageC1	DC busbar under-voltage or voltage drop error of compressor 1
38	DC over-voltageC1	DC busbar over-voltage or voltage drop error of compressor 1
39	IPM errorC1	IPM failure of compressor 1
40	Startup failureC1	Startup failure of compressor 1
41	Dri-Mod resettingC1	Drive module resetting of compressor 1
42	Comp-Over-currentC1	Over-current of compressor 1
43	Current circuit SEC1	Current sensing circuit error or current sensor error of compressor 1
44	DesynchronizingC1	Desynchronizing of compressor 1
45	Comp-Dri-Comm-EC1	Communication error to the drive of compressor 1
45	HS-IPM-PFC over-TC1	Heat sink or IPM or PFC over-temperature of compressor 1
47	HS-IPM-PFC SEC1	Heat sink or IPM or PFC temperature sensor error of compressor 1
48	Charging circuit-EC1	Charging circuit error of compressor 1
48	DC under-voltageC2	DC busbar under-voltage or voltage drop error of compressor 2
50	DC over-voltageC2	DC busbar over-voltage or voltage drop error of compressor 2
51	IPM errorC2	IPM failure of compressor 2
52	Startup failureC2	Startup failure of compressor 2
53	Dri-Mod resettingC2	Drive module resetting of compressor 2
54	Comp-Over-currentC2	Over-current of compressor 2
55	Current circuit SEC2	Current sensing circuit error or current sensor error of compressor 2
56	DesynchronizingC2	Desynchronizing of compressor 2
57	Comp-Dri-Comm-EC2	Communication error to the drive of compressor 2
58	HS-IPM-PFC over-TC2	Heat sink or IPM or PFC over-temperature of compressor 2
59	HS-IPM-PFC SEC2	Heat sink or IPM or PFC temperature sensor error of compressor 2
60	Charging circuit-EC2	Charging circuit error of compressor 2
61	DC under-voltageF1	DC busbar under-voltage or voltage drop error of fan 1
62	DC over-voltageF1	DC busbar over-voltage or voltage drop error of fan 1
63	IPM errorF1	IPM failure of fan 1

No	Short Name	Full Name
64	Startup failureF1	Startup failure of fan 1
65	Dri-Mod resettingF1	Drive module resetting of fan 1
66	Fan-Over-currentF1	Over-current of fan 1
67	Current circuit SEF1	Current sensing circuit error or current sensor error of fan 1
68	DesynchronizingF1	Desynchronizing of fan 1
69	Fan-Dri-Comm-EF1	Communication error to the drive of fan 1
70	HS-IPM-PFC over-TF1	Heat sink or IPM or PFC over-temperature of fan 1
71	HS-IPM-PFC SEF1	Heat sink or IPM or PFC temperature sensor error of fan 1
72	Charging circuit-EF1	Charging circuit error of fan 1
73	DC under-voltageF2	DC busbar under-voltage or voltage drop error of fan 2
74	DC over-voltageF2	DC busbar over-voltage or voltage drop error of fan 2
75	IPM errorF2	IPM failure of fan 2
76	Startup failureF2	Startup failure of fan 2
77	Dri-Mod resettingF2	Drive module resetting of fan 2
78	Fan-Over-currentF2	Over-current of fan 2
79	Current circuit SEF2	Current sensing circuit error or current sensor error of fan 2
80	DesynchronizingF2	Desynchronizing of fan 1
81	Fan-Dri-Comm-EF2	Communication error to the drive of fan 2
82	HS-IPM-PFC over-TF2	Heat sink or IPM or PFC over-temperature of fan 2
83	HS-IPM-PFC SEF2	Heat sink or IPM or PFC temperature sensor error of fan 2
84	Charging circuit-EF2	Charging circuit error of fan 2

(4)Error Records

Operation Instructions

By touching “**Error record**”, the controller will access to the current error record page.

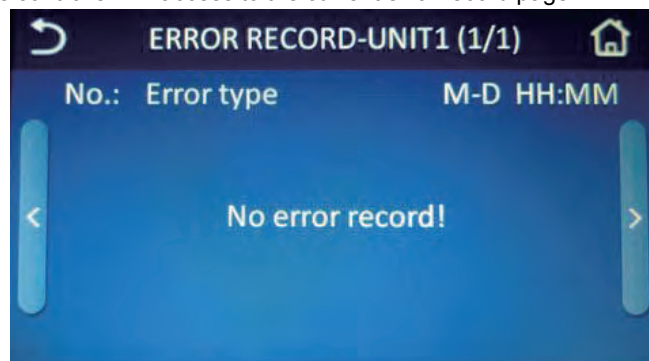

[Notes]

Each error record includes the error number, error name, month, day, hour, and minute. The latest error lists in the top.

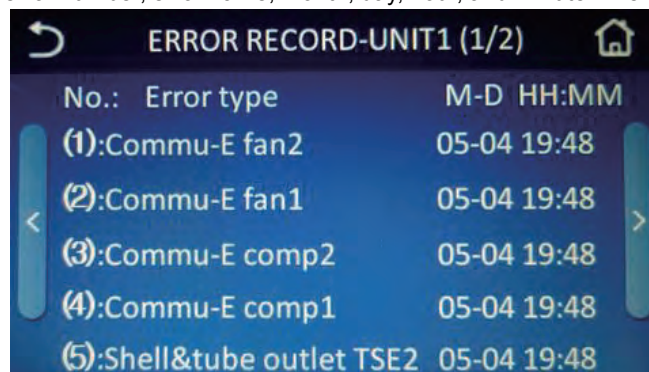

At most 10 pieces of error records can be saved for each unit. When it exceeds 10, the earlier ones will be deleted, which will not affect the error records of any other units.

(5) **Bar Codes**

Operation Instructions

By touching “Bar code”, it will go to the bar codes page, as shown in the figure below.

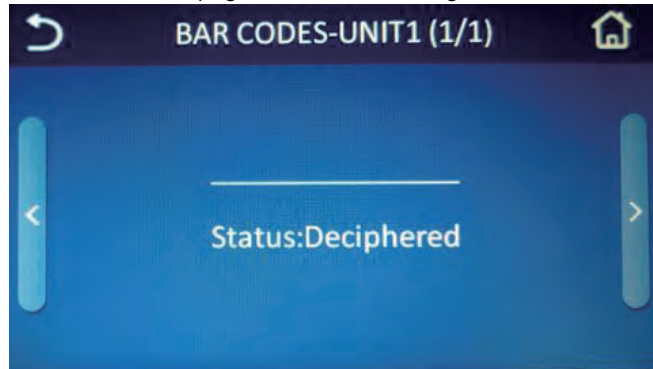

4.5.5 **E-Clear**

Operation Instructions

At the menu page, touching “E-clear”, it will access to the error clear page. At this page, it is able to operate error clearing and discharge failure unlocking.

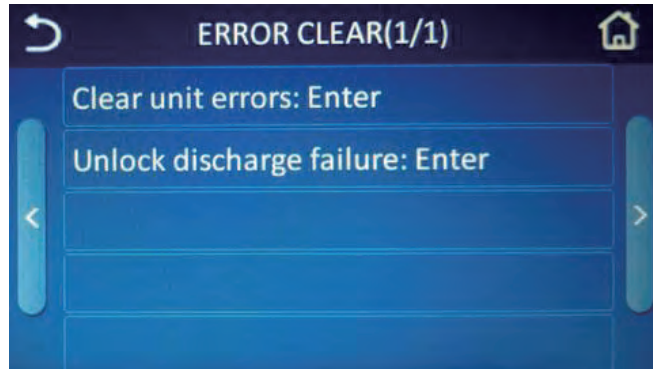

(1) **Clear Unit Errors**

Operation Instructions

At the “**ERROR CLEAR**” page, by touching “**Clear unit errors**”, the control panel will access to the page as shown below.

Then, by selecting “**Yes**” and “**OK**”, this operation will succeed and go back to the “**ERROR CLEAR**” page.

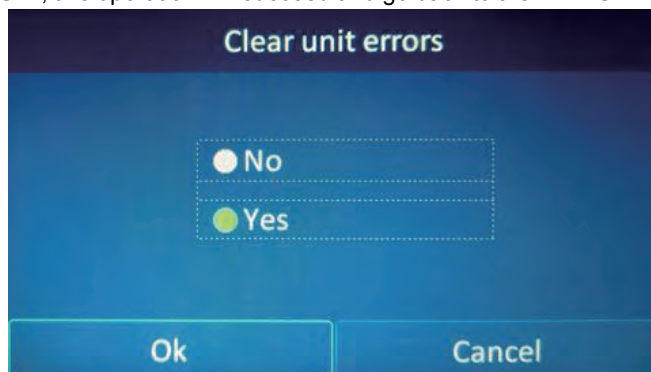

[Notes]

- 1) When touching “Yes” and then “OK”, this operation will succeed.
- 2) When touching “No” or “Cancel”, this operation will quit and the unit will do not do any operation.
- 3) After this operation, all recovered errors for all on-line units will be cleared; for those unrecovered, there will still be alerts.

(2)Unlock Discharge Failure

Operation Instructions

At the “**ERROR CLEAR**” page, by touching “**Unlock discharge failure**”, the control panel will access to the page as shown below. Then, by selecting “**Yes**” and “**OK**”, the discharge failure will be unlocked; or by selecting “**Cancel**”, this operation will quit and go back to the “**ERROR CLEAR**” page.

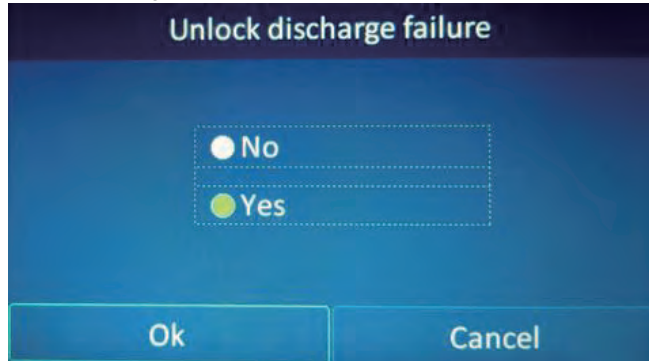

[Notes]

When the error of discharge failure has been eliminated, this setting can unlock the discharge failure and the corresponding locked unit can be restarted.

4.5.6 General

Operation Instructions

At the function setting page, by touching “**GENERAL**”, the control panel will go to the corresponding setting page, where system clock, key tone and backlight and other general functions can be set, as shown in the figure below.

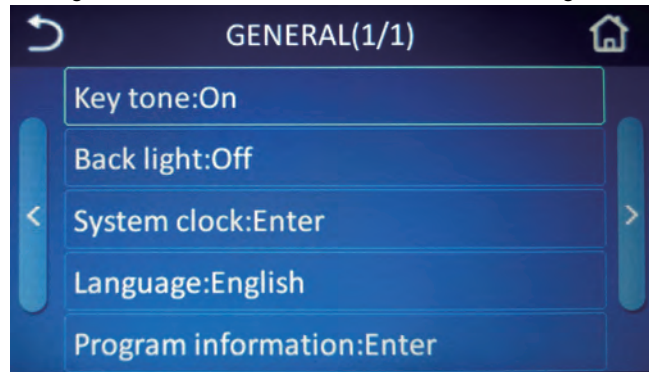

Figure 4-18 General Page 1

No	Function	Range	Default	Remarks
1	Key tone	On/Off	On	/
2	Back light	On/Off	Off	“ On ” indicates the controller will always light on. “ Off ” indicates that when it is detected that there is no any operation in five minutes the controller will light off.
3	System clock	Enter	/	/
4	Language	Chinese/English	English	/
5	Program information	Enter	/	/

(1)Key Tone

Operation Instructions

At the function setting page, by touching **GENERAL**, the control panel will go to the corresponding setting page. Then, by touching **Key tone**, it can be set to **On** or **Off**, as shown in the figure below.

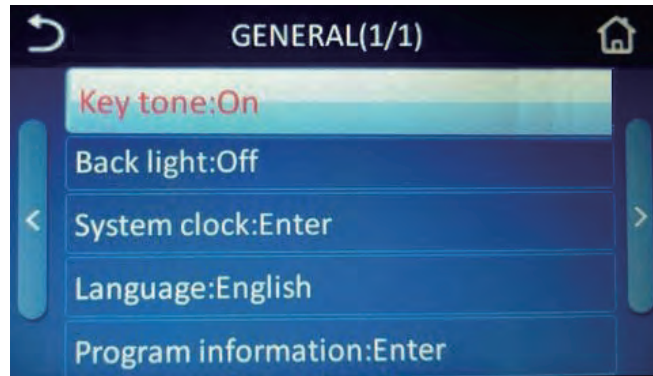

Figure 4-19 General Page with Activated Key Tone

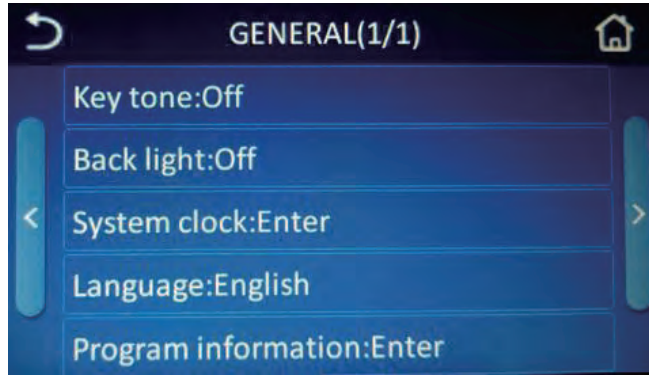

Figure 4-20 General Page with Deactivated Key Tone

(2) Backlight

Operation Instructions
Refer to Section 2.6.1

(3) System Lock

Operation Instructions

- 1) At the function setting page, by touching "GENERAL", the control panel will go to the corresponding setting page. Then, by touching "System clock", the controller will access to the system clock setting page, as shown in the figure below.

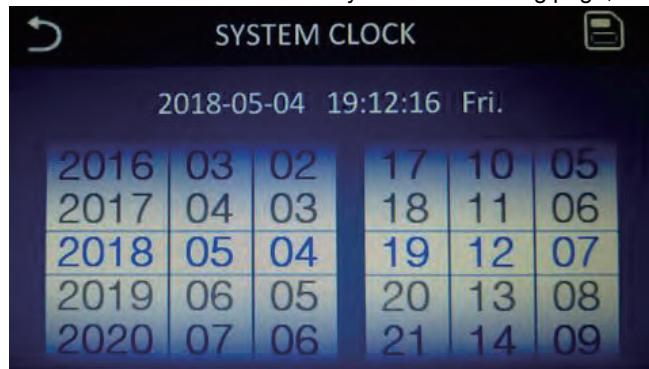

- 2) The setting value for the system clock can be changed by the sliding the blue digits. Then, by touching the saving icon, this setting will be saved and rightly take effective. While, by touching the back icon, this setting will not be saved and the controller will back to the general setting page.

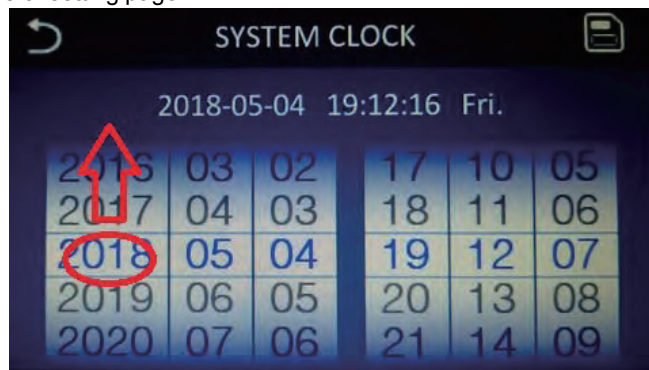

(4) Language Setting

Operation Instructions

- 1) At the function setting page, by touching **“GENERAL”**, the control panel will go to the corresponding setting page. Then, by touching **“Language”**, the controller will access to the language setting page, as shown in the figure below.



- 2) Select the desired language. Then, by touching **“OK”**, this setting will be saved and take effective; while by touching **“Cancel”**, this setting will not be saved and the controller will back to the general setting page.

(5) Program Information

Operation Instructions

At the function setting page, by touching **“GENERAL”**, the control panel will go to the corresponding setting page. Then, by touching **“Program information”**, the controller will access to the program checking page, as shown in the figure below.

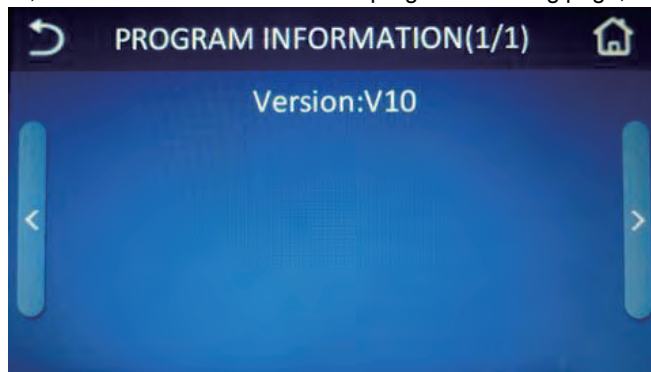

[Notes]

“Version” indicates the program version for the control panel.

4.5.7 Setup of Toggle Switches on the Motherboard

Five-bit toggle switches are used for indicating hardware address (1~16) of modules, with module No. displayed in turn on the panel as Module 1, Module 2,, Module 16. Toggle switches 1,2,3,4 and 5 are binary codes, with 1 for the lowest bit and 5 for the highest bit. Comparison drawings are as follows (Caution: only in the condition of power supply shutoff can toggle switches be set):

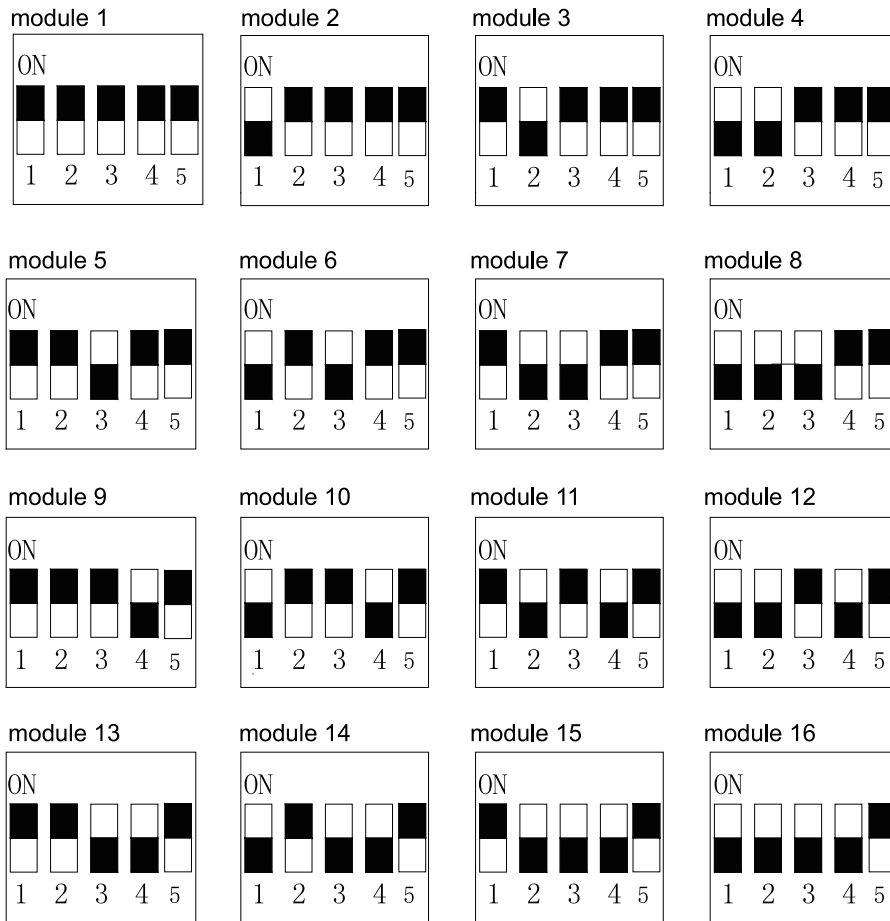

Note: the black block represents where the projecting lever of the toggle switch is.

4.6 Smart Management System

4.6.1 Long-distance Monitoring/BMS Interface

This long-distance monitoring system allows users through a computer to remotely monitor up to 255 variable-frequency modular-type chillers, including turning on/off the units, setting parameters, giving alarms for malfunctions, which is an efficient tool for management of intelligent air conditioning systems for modern buildings.

4.6.2 Network of the Long-distance Monitoring System

4.6.2.1 Net Topological Diagram

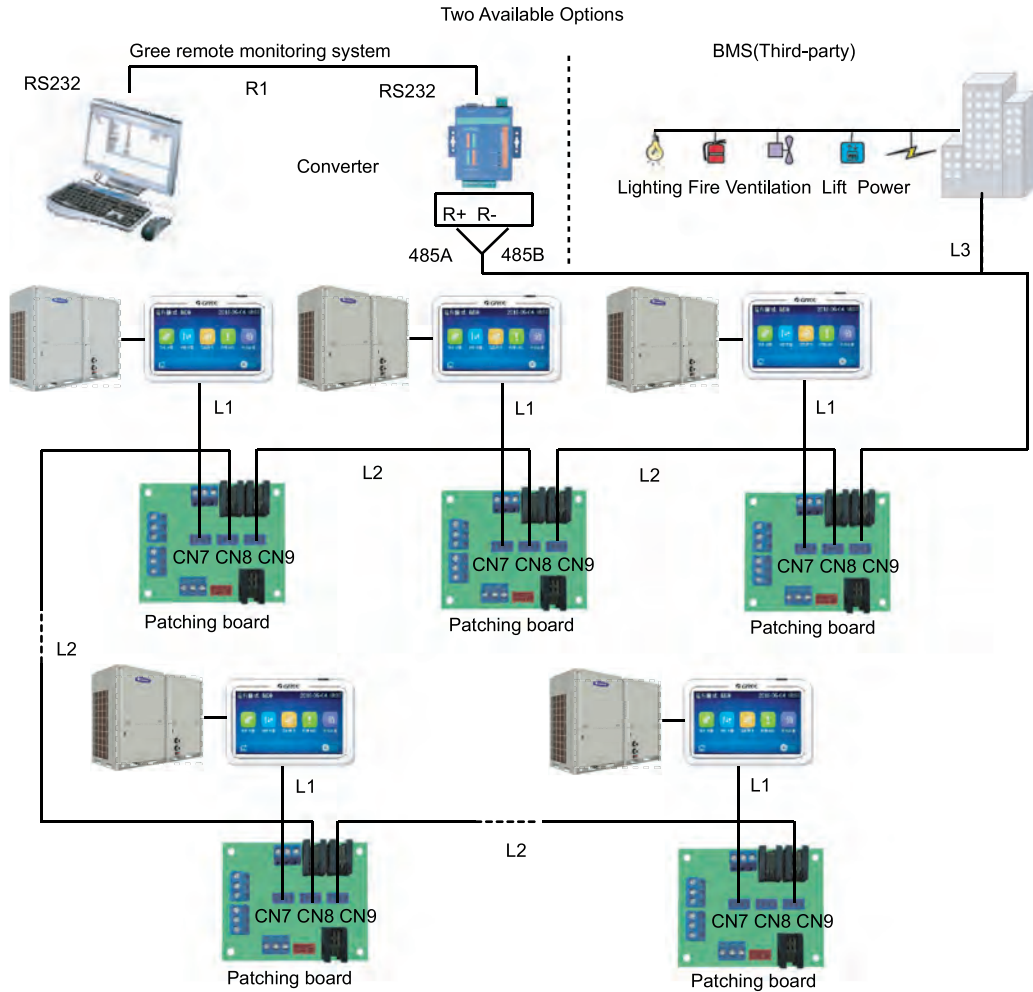

Note: the system as shown in the figure above consists of 1~16 single units depending on the actual demand of the project.

From the topological diagram above, the long-distance monitoring system consists of 3 parts :

The first part is the BMS and the converter used to convert RS232 signals from the BMS into RS485 signals of the long-distance monitoring network.(it is required only when RS232 is used for the BMS)The second part refers to the communication network, that is, the communication lines and the connected hardware.

The second part refers to the communication network, that is, the communication lines and the connected hardware.

The third part is the patching board responsible for the data exchange between the air conditioning system and the monitoring PC. When there is only one unit, the patching board is not required and RS485 signal lines from BMS can be directly connected to the BMS port of the control panel. When there are multiple units, signal lines from BMS are required to be connected to the BMS port through the patching board.

4.6.2.2 Communication Lines

Line Code	Description	Type
L1	Category-5 twisted pairs, two four-wire connectors, one for the communication patching board, the other for the unit.	S
L2	Category-5 twisted pairs, two four-wire connectors	S
L3	Category-5 twisted pairs, one four-wire connector for the communication patching board, the other connector for RS232-485 photoelectric converter.	O
R1	DB9 serial port line	S

S= Standard O= Optional P= Purchased by users

4.6.3 Hardware

4.6.3.1 Parts List

Name	Model	Code	Remarks	Type
Optoelectronic isolated repeater	RS485-W	LN02200010	A repeater is required every 800m communication distance or every 30 communication nodes (control panels).	P
Optoelectronic isolated converter	GD01	LN02200020	It is required when there is no remote monitoring kit but RS232 communication is used.	P
Remote monitoring kit	FG30-00/A(M)	MC200027	It is for remote monitoring other than BMS. Other main parts: monitoring software disc, optoelectronic isolated converter	S
Communication patching board	CF159	LN01201090	It is required when several units forms a network. It is intended to connect two or three communication lines.. Other main parts: communication patching board (with fixed support), connection line	P

S= Standard O= Optional P= Purchased by users

Notes

- (1)When distance between the output of the BMS system or the output of the optoelectronic converter to CN4 of the display panel exceeds 800m, an optoelectronic repeater is required to reinforce signals.
- (2)The optoelectronic repeater is also required between the CN5 of the display panel and the main board for extending the communication distance.

4.6.4 Model Selection Instructions

4.6.4.1 Rules for Model Selection

4.6.4.1.1 Supply Scope

Item	Model	Type	Remarks
Computer	\	O	CPU : Pentium 4 or above
			Memory : 512M or above
			Hard disc : 30G or above
			Serial port: 1 at least
			Operation system : Windows XP/ Windows 2003/Windows Vista/ Windows 7
Remote monitoring kit	FG30-00/A(M)	S	It is for remote monitoring other than BMS. Other main parts: monitoring software disc, optoelectronic isolated converter
Communication patching board	ZTSJ0	P	It is required when several units forms a network.
Optoelectronic isolated converter	GD02	P	It is required when there is no remote monitoring kit but RS232 communication is used.
Optoelectronic isolated repeater	RS485-W	P	A repeater is required every 800m communication distance or every 30 communication nodes (control panels).
4-core (2-core) category 5 twisted pairs	\	O	Its length depends on the actual demand.

S=Standard O=Optional P=Purchased by users

4.6.4.1.2 Selection of Part Quantity

Model	Communication patching board	Remote monitoring kit	Optoelectronic repeater
A series modular type chiller	One patching board for one unit	1)one set of remote monitoring kit FG30-00/A(M) is required ; 2)the remote monitoring kit is not required when the unit is directly connected to the BMS system.	A repeater is required every 800m communication distance or every 30 communication nodes (control panels).

4.6.4.2 Examples of Model Selection

4.6.4.2.1 Example 1

This project consists of 3 LSQWRF60VM/NaA-M, one control panel and BMS. The maximum communication distance is within 800m. The BMS interface is RS232 and one converter is required.

Name	Code	Quantity
Air conditioning system	EL01500720	1(3 LSQWRF60VM/NaA-M)
Optoelectronic converter	EN02200020	1

4.6.4.2.2 Example 2

This project consists of 7 groups LSQWRF60VM/NaA-M, six groups concluding 3 and the other concluding 1. Seven control panels are required. The communication distance is larger than 800m but be or less than 1600m. One repeater is required for somewhere the communication distance is over 800m. The BMS interface is RS485.

Name	Code	Quantity
A series variable-frequency modular type chiller	EL01500720	19 LSQWRF60VM/NaA-M
Accessory XE73-25/G	NC20700050	7
Patch board ZTSJ0	30118023	6
Optoelectronic repeater RS485-W	EN02200010	1

4.6.4.2.3 Example 3

This project consists of 35 air conditioning systems including 103 LSQWRF60VM/NaA-M units. Among then, there are 34 air conditioning systems which consists of 3 LSQWRF60VM/NaA-M. The remaining consists of 1 LSQWF65M/NaE-M. Totally 35 control panels are required. A repeater is required for somewhere the communication distance is over 800m but less than 1600m and when the communication nodes (control panels) exceeds 35. The BMS interface is RS232. Besides, one converter is required.

Name	Code	Quantity
A series variable-frequency modular type chiller	EL01500720	103 LSQWRF60VM/NaA-M
Accessory XE73-25/G	NC20700050	35
Patch board ZTSJ0	30118023	34
Optoelectronic repeater RS485-W	EN02200010	2
Optoelectronic converter GD02	EN02200020	1

5 Unit Installation

5.1 Installation Flowchart

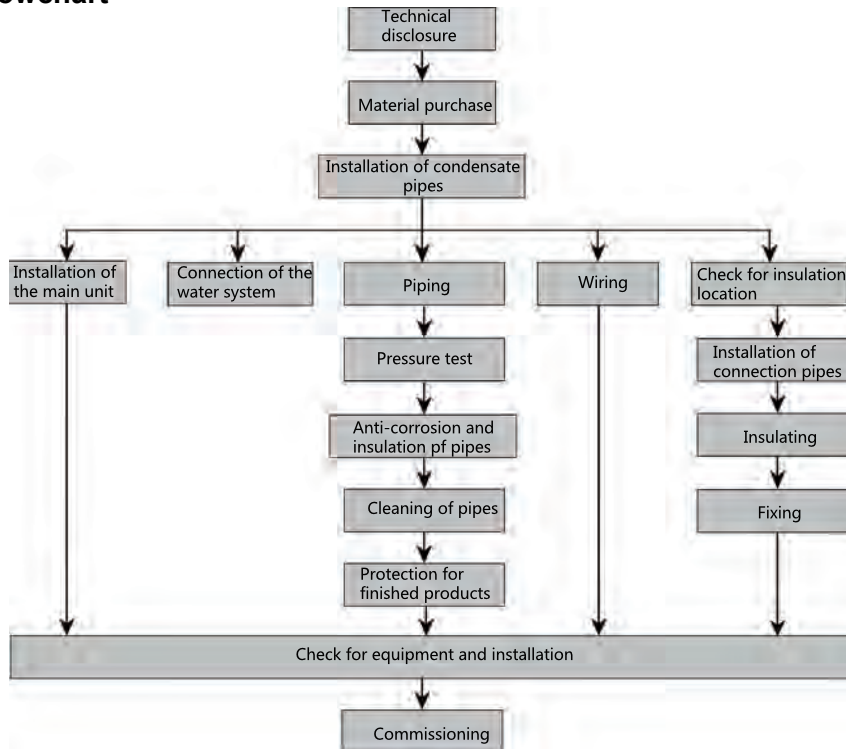

5.2 Preparations before Installation

5.2.1 Precautions for Installation

⚠ WARNING

- (1) Installation should be performed by GREE appointed servicemen, or improper installation would lead to unusual operation, water leakage, electric shock or fire hazard.
- (2) The unit should be installed on the foundation which is capable of supporting the unit, or the unit would fall off or even lead to personal injury.
- (3) All electric installation should be done by electrician in accordance with local laws and regulations, as well as the User's Manual and this Service Manual. Besides, the special power lines should be used, as any improper line would lead to electric shock or fire hazard.
- (4) All electric lines should be safe and secured reliably. Be sure the terminal board and electric lines will not be affected by any external force, or it would lead to fire hazard.
- (5) The electric lines between the indoor and outdoor units should run properly to make the cover of the electric box secured tightly, or it would cause the terminal board overheated or cause electric shock or fire hazard.
- (6) Cut off the power supply before touching any electric element.

⚠ CAUTION

- (1) The unit should be grounded properly and the ground line is not allowed to connect with the gas line, water line, lightning rod or phone line.
- (2) The breaker should be installed, or it would lead to electric shock.
- (3) The drain pipe should be installed in accordance with the User's Manual and this Service Manual to ensure free drainage, and the drain pipe should be insulated against condensation. Once the drain pipe is installed improperly, it would lead to water leak which then will damps the ceiling and furniture.
- (4) Do not place the unit where there is oil fog, like kitchen, or the plastic would be aged, broken off or the polluted evaporator would lead to water leak and poor performance.
- (5) Do not place the unit where there is corrosive gas (like sulfur dioxide), or the corroded copper tubes or welded joint would lead to refrigerant leakage.
- (6) Do not place the unit where there is inflammable gas, carbon fiber, inflammable dust or volatile combustible, as they would lead to fire hazard.

⚠CAUTION

- (1) Always use safety outfits at the construction site.
- (2) No smoking and no drunken operation are allowed at the construction site.
- (3) Wear no gloves and tighten the cuff when operating the machinery and electrical equipment. Do not maintain it during operation.
- (4) Use the abrasive-disk cutter and stand at the side of the rotating abrasive disk.
- (5) Clean the opening when installing the riser pipe, and then cover it tightly. Do not throw down any material.
- (6) The use of the electric and gas welders should be approved firstly. Once used, a fire extinguisher should be prepared and a service man should be there always. There should be no inflammable and explosive substances around the welding site.
- (7) A platform should be set up when working high above the ground.

Executive Standards, Codes and Regulations

- (1) Fire protection design of tall buildings GB50045-95.
- (2) Code of design on building fire protection and prevention GB50016-2006.
- (3) Code for electric design of civil buildings JGJ16-2008.
- (4) Technical specification or construction of air conduct JGJ141-2004.
- (5) Unified standard for constructional quality acceptance of building engineering GB50300-2001.
- (6) Code of acceptance for construction quality of ventilation and air conditioning works GB50243-2002.
- (7) Code for acceptance of construction quality of water supply drainage and heating works GB50242-2002.
- (8) Code for construction and acceptance of refrigeration and air separating equipment installation engineering GB 50274-2005.

5.2.2 Importance of Installation

See the table below for problems occurred frequently and caused influences.

No.	Typical Problems	Caused Influences
1	Inadequate space for installation	It would lead to harder maintenance, poor ventilation, poor heat exchanging or even abnormal operation.
2	Improper piping of the water system	The unit would fail to run normally.
3	Improper cleaning for water piping	It would make foreign matters enter the water system, which then would lead to heavy scaling on the heat exchanger, cracked or leaked heat exchanger.
4	Mis-wiring of power lines	It would damage the electric element and lead to safety hazards.
5	Mis-wiring of communication lines	It would lead to abnormal communication.
6	Improper protection to the communication lines	The unit would fail to run with the communication fault.
7	Poor insulation for the chilled water lines	Missed, cracked, unqualified insulation and insulation with inadequate thickness would lead to poor heat exchanging.
8	Unqualified vibration reduction measures	Unqualified vibration reduction measures would lead to increased vibration and noise, or even abnormal operation.
9	No protective sleeve for the wall-thru water pipes	Water leak would be led to by friction between the wall-thru pipe and the wall.
10	Improper arrangement of equipment and pipes	Improper arrangement would make the machine room look messy.

The installer should be qualified and well know special requirements on installation so as for guaranteeing installation quality. Only trained and passed technicians are allowed for installation.

Welders, electricians and refrigeration mechanics all should be licensed.

5.2.3 Selection of Installation Materials

Requirements on Materials

Models, specifications and material of pipelines, pipe fittings, and valves of the water system should comply with the corresponding design codes.

Specifications of the galvanized carbon steel tubes also should comply with the corresponding design and production codes: evenly galvanized internal and external tube walls, no rust, no burrs, and no unmatched thread etc. All tubes should have got the qualification certificates and other necessary quality certificates.

5.2.3.1 Pipelines

Application	Type
Water (t > 95°C) lines	Welded steel, seamless steel, galvanized steel
Water (t ≤ 95°C) lines	Welded steel, seamless steel, galvanized steel, nodular cast iron, composited aluminum and plastic (PAP1, XPAP2, RPAP5), PB, PE-X
Water (t ≤ 60°C) lines	Welded steel, seamless steel, galvanized steel, PP-R, composited aluminum and plastic (PAP1, XPAP2, RPAP5), PB, PE-X, PE-RT
Cooling wter lines	Welded steel, seamless steel, galvanized steel, nodular cast iron
Drain lines	PVC,UPVC
Condensation lines	Galvanized steel, PE, PVC, UPVC



5.2.3.2 Insulation

Typically the refrigerant copper tubes, air ducts, chilled water tubes and condensation tubes should be thermally insulated by the commonly used plastic insulation rather than glass wool, PE or PEF.

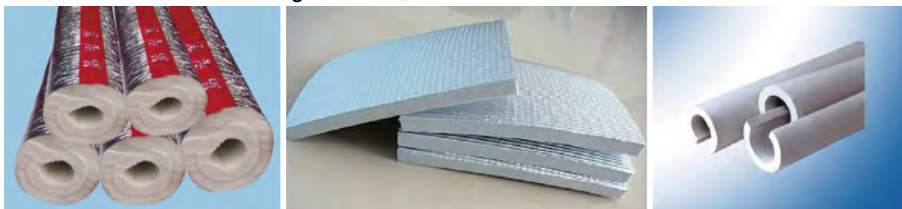

Diameter(mm)	Gas-expanded Rubber		Glass Wool	
	I	II	I	II
DN15 ~ DN25	> 15mm	> 20mm	> 30mm	> 30mm
DN32 ~ DN50	> 25mm	> 30mm	> 35mm	> 35mm
DN65 ~ DN80	> 30mm	> 35mm	> 35mm	> 40mm
≥DN100	> 35mm	> 40mm	> 40mm	> 45mm

Note: under the tropical climate, the insulation should be thickened or doubled.

Zones in China are classified by the degree of humidity.

Zone I: Beijing, Tianjin, Chongqing, Xi'an, Hangzhou, Zhengzhou, Changsha, Nanchang, Shenyang, Changchun, Herbing, Jinan, Shijiazhuang, Guiyang, Taipei.

Zone II: Shanghai, Nanjing, Wuhan, Dalian, Fuzhou, Xiamen, Gumming, Chengdu, Nanning, Hong Kong, Macao, Guangzhou, and other coastal cities.

Thickness listed in the table above all is larger than the required thickness.

Special adhesives for insulation should be used, as shown in the figure below.



5.2.3.3 Sectional Materials

- ◆Angle Steel ◆I steel ◆Channel Steel ◆Squire Steel ◆Rectangular Steel ◆H Steel



5.2.3.4 Valves

The usually used valves include: gate valves, shut-off valves, throttling valves, gauge valves, plunger valves, diaphragm valve, plug valves, ball valves, butterfly valve, check valves, safety valves, drain valves, regulating valves, foot valves, and sewer valves etc.

(1) Gate Valve: its nominal diameter generally is or larger than 50mm and is mainly used to cut off the tube flow.



(2) Shut-off Valve and Throttling Valve: its nominal diameter is limited to 200 or below. The shut-off valve is used to cut off the tube flow and the throttling valve is mainly used to throttle the tube flow.



(3) Ball Valve: it is mainly used to cut off or distribute the tube flow or change its direction.



(4) Butterfly Valve: it is widely applicable to all kinds of fluids under 2.0Mpa and 200°C.

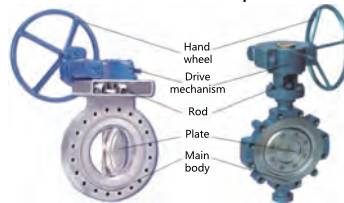

(5) Plug Valve: it is mainly used to cut off or distribute the tube flow or change its direction.



(6) Check Valve: it mainly used to stop the fluid flow back.

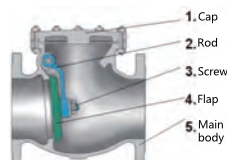

(7)Balance Valve: it is capable of controlling the flow rate and is mainly used to balance the hydraulic pressure of the pipeline system.



(8)Selection of Valves

Item	No	Selection Principle
Design	1	Butterfly valves for the inlet and outlet of the chilled water and cooling water tubes.
	2	Butterfly valves for the water pump inlet; check and butterfly valves for the water pump outlet.
	3	By-pass valves between the water header and the distributor.
	4	Butterfly valves for the inlet or return water tubes.
	5	Butterfly valves for the horizontal main tubes.
	6	Gate valves, filters, electric 2-way valves or electric 3-way valves for the air handling units.
	7	Gate valves (or with electric 2-way valve) for the fan coil units.
For butterfly valves, the one which diameter less than 150mm is the hand-wheel type; the one which diameter is large than 150mm is the worm-gear drive type.		
Precautions	1	The reducing valves and balance valves should work together with by-pass valves.
	2	Ball valves and gate valves are the best choice for the full-open and full-close type valves.
	3	The shut-off valves should be avoided to the most extent.
	4	Pay much attention to the calculation of the resistance of the valves.
	5	Choose the proper electric valves.
Valves for Water Supply Pipes	1	Regulating and shut-off valve are good choices when the water flow and pressure should be regulated.
	2	Gate valves are good choices when the water resistance is required to be small.
	3	Butterfly and ball valves are good choices when the installation space is small.
	4	Shut-off valves should be used when fluid flows in two directions.
	5	Multi-function valves are good choices for the water pump with large diameter.
Setup Location of Check Valves		
Setup Location	1	At Influent pipes
	2	At the inlet pipe of the closed water heater or water treatment equipment.
	3	At the outlet pipe of the water pump.
	4	At the outlet pipe used also as the inlet pipe of the water tank, water tower and high-level water pool.
	Note: the check valve is not required for the pipe with the backflow preventer	
Type Selection of Check Valves	It depends on the installation location, upstream water pressure, sealing performance and size of the water hammer etc.	
	1	Swing, ball and shuttle-type check valves are good choices when pressure upstream is small.
	2	Spring-type check valves are good choices when there is high requirement on the sealing performance.
	3	Quick-closing check valves or slow-shut check valves with damping devices are good choices when the water hammer is required to be reduced.
4		The valve clack should be automatically closed with force of gravity or spring force.
Release Valves Required for the Water Supply Pipes	1	At the end and the highest point of the water supply network.
	2	At the peak of some pipe section in the water supply network where a huge amount of air is trapped.
	3	At the highest point of the water supply network equipped with an automatic pneumatic water tank.

5.2.3.5 Filters for the Water System

The most commonly used filter is the Y-shaped filter which is usually installed at the inlet of the water pump, reducing valve, locating valve, or other equipment. It is used to remove impurities in the water system so as to protect valves and make the unit run normally. Its mesh number generally is 18~30.



e.g. 1: YBY350II-4.0/40B: it indicates YBY series, 350 nominal diameter, 4.0MPa, II, stainless steel, 40 meshes/ inch.

e.g. 2: YBY250III-1.6/60 A : it indicates YBY series, 250 nominal diameter, 1.6MPa, III, stainless steel, 40 meshes/inch

5.2.3.6 Water Softeners

Water at the construction site is likely to be hard, which would cause heavy scale on the pipes. Therefore, a water softener should be installed in the unit. Generally, an automatic softener is preferred.

Electric Water Treating Equipment: it is used to remove impurities, hydrocarbonate, bacterial, algae etc. in the cooling water.







5.3 Tools

5.3.1 Cutting and Finishing Tools

It mainly includes: abrasive-disc cutter, hand abrasive wheel, chain blocks, electric drill, threading machine, pressure test device, handsaw, pipe wrench, box wrench, monkey wrench, hammer, and electric welder etc.

5.3.2 Measuring Tools

It mainly includes: steel band tape, level bar, angle square, U-shaped pressure gauge etc.

Name	Image	Usage
Electric Welder		to weld tubes
Abrasive-disc Cutter		to cut steel tubes
Chain Blocks		to install tubes
Pipe Wrench		to install tubes

Name	Image	Usage
Percussion Drill		to install brackets
Thread Taper		to draw threads
Hand Mill		to install tubes
Hand Electric Drill		to drill holes
Steel Band Tape		to measure length
Level Bar		to judge the levelness
Booster Pump		to pressurize tubes
Oxygen Lance		to cut steel tubes

5.4 Installation Instructions

5.4.1 Outline Dimensions

(1)LSQWRF35VM/NaA-M(unit:mm)

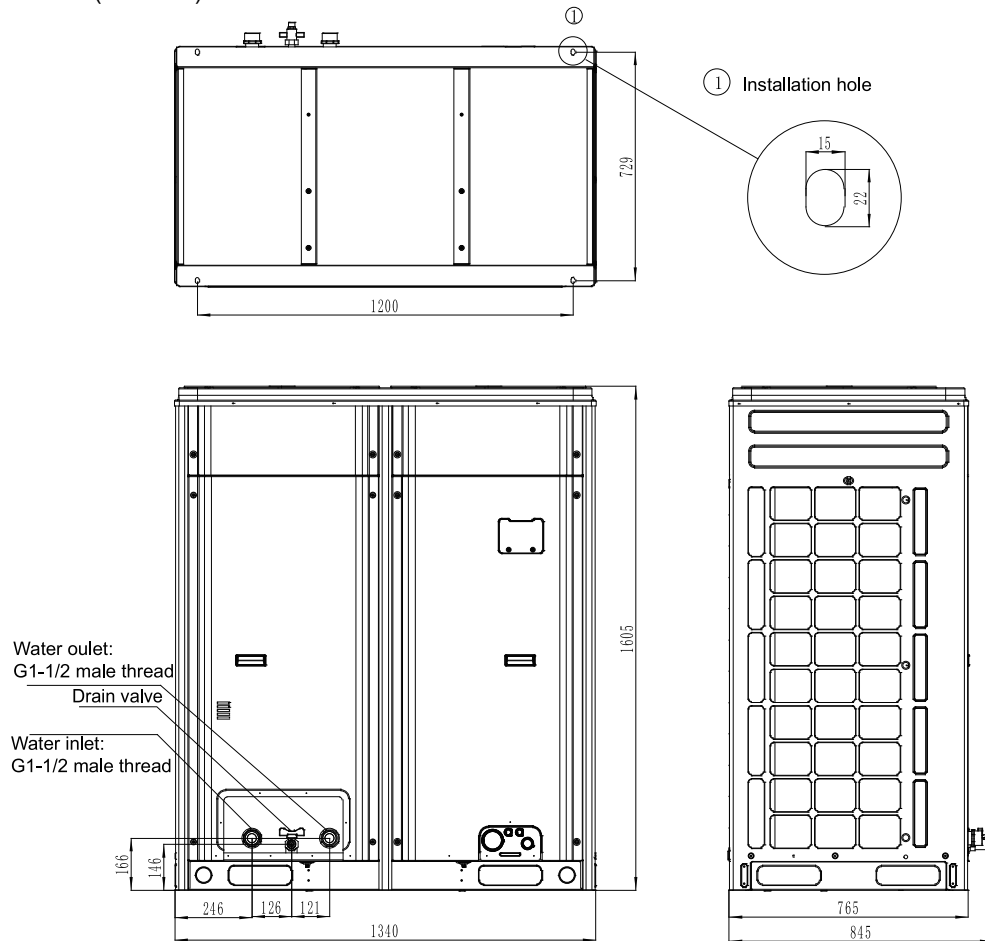

(2)LSQWRF60VM/NaA-M, LSQWRF65VM/NaA-M (unit:mm)

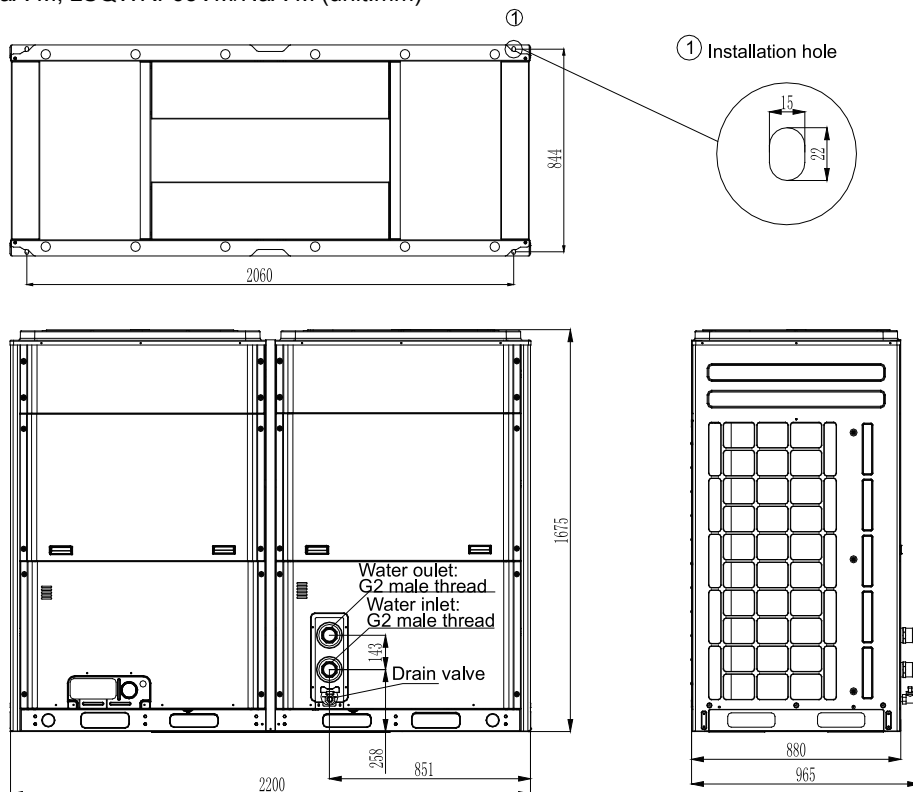

5.4.2 Precautions for Installation

(1) Pipelines and electric lines should be correctly connected.

- (2) Rubber pads and rubber flexible connectors should be used during installation for noise and vibration reduction.
- (3) Under subzero climate, when the heat pump runs for cooling, anti-freeze liquid is required.
- (4) Dedicated lugs should be used for lifting. During lifting, proper protection should be taken so as to avoid pipelines from being damaged.

5.4.3 Installation Environment

- (1) The unit should not be installed within 25m of the residence; otherwise a sound insulating wall should be set up.
- (2) When the unit is to be installed at the roof, the foundation should be located at the heel posts. If the floor is quite thin, or there is VIP rooms under the floor, the spring damper is required.
- (3) Fire, inflammably, corrosive gas and waste gas should be avoided around the unit. Also, the unit cannot be installed around the chimney and discharge fan.
- (4) Ventilation should be in good condition and no air flow would be trapped.

5.4.4 Installation and Service Space

The interval between each single unit should be larger than 0.5m so that there is enough space for entering air and maintenance. The distance between the unit and any barrier should be or larger than 1m so as to keep good ventilation around the unit. If possible, a suncover can be set up 3m ahead of the unit.

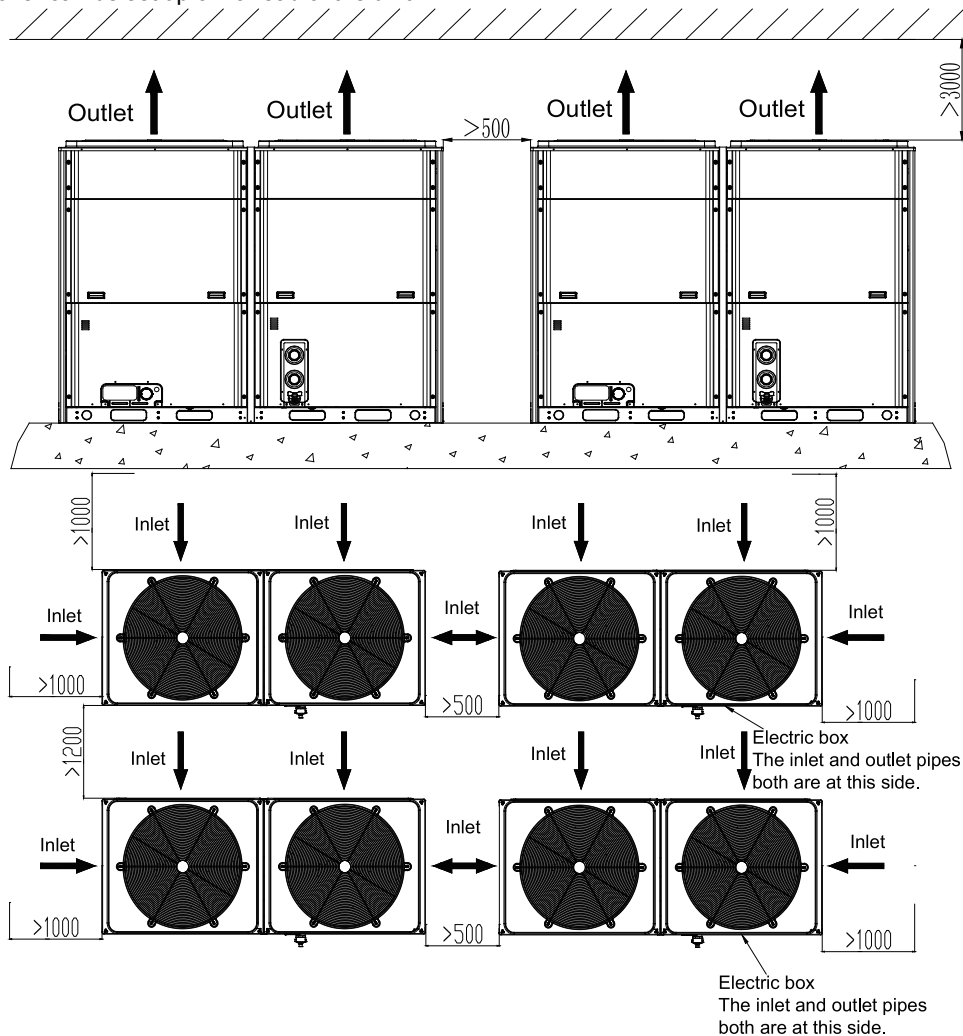

5.4.5 Installation Foundation

- (1) The installation foundation should be designed by qualified designers.
- (2) The foundation should be made of cement or steel structure and be capable of supporting the weight of the unit. Additionally, the upper surface should be kept level. It would be better to keep drain grooves around the foundation.
- (3) The installation should be secure enough, and its surface should be smooth.

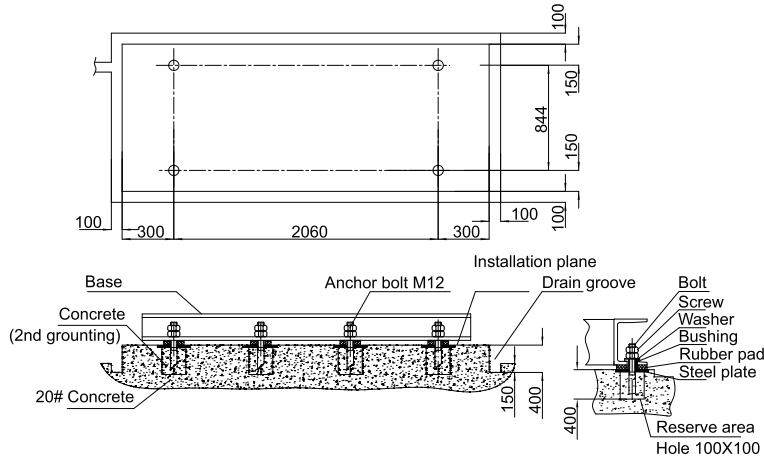

5.4.6 Handling and Lifting

Handling and lifting of the main unit should be performed by a qualified installation team. During lifting, the main unit should be kept stable both horizontally and vertically.

5.4.6.1 Handling and Lifting

Each unit will undergo a series of strict factory inspections and tests to guarantee the expected performance and quality. However, special attention should be paid during handling and shipping to prevent the control system and the piping system from being damaged.

The unit should be moved by the forklift or hoisting machine. During lifting, the canvas lifting or steel ropes in use should be of enough strength and go through the based and then bundled tightly. The unit should be lifted stably from four corners. Meanwhile, be sure there should be protective pads to prevent lifting ropes contacting with the unit. The inclination angle during lifting should be less than 15 degree. The unit should be moved softly and severe collision and forced drag are not allowed. Please do lifting as shown in the figure below for units with similar structure.

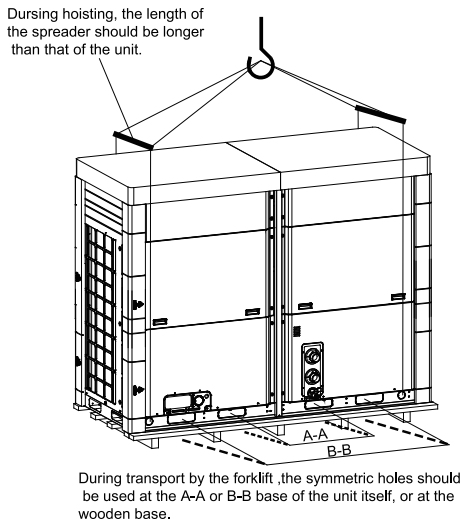

5.4.6.2 Placement of the Main Unit

- (1) Place the unit on the foundation.
- (2) There should be no clearance between the foundation and the baseboard of the unit.
- (3) Lift the unit, put the rubber pad on the foundation and then place the unit on the rubber pad.

After that, be sure the horizontal slope of the unit can't exceed 1/1000. If so, take an adjustment by stuffing spacers into the clearance between the foundation and the baseboard of the unit until the slope is satisfactory.



5.5 Piping and Insulation

5.5.1 Installation of the Water System

■ Considerations stated below shall be taken carefully for the water system.

- (1) Each water inlet and outlet should be labeled properly to avoid misconnection.
- (2) A flexible connector should be used at the chilled water outlet to reduce vibration transmission.
- (3) A manometer, a thermometer and a gate valve shall be installed at the chilled water inlet /outlet. Moreover, a drain valve shall be installed at the outlet and an air release valve shall be installed at the inlet. At the highest point of the water system, another release valve shall be installed, while at the lowest point of the water system, another drain valve shall be installed to facilitate drainage.
- (4) The water inlet/outlet pipe should be tightly insulated to reduce heat loss and dewing. When pipes are exposed under 0°C, a electric heater shall be installed.
- (5) There surely be some foreign matters in the water system which would generate scale on the surface of the heat exchanger, so a filter shall be installed upstream of the water pump.
- (6) The unit shall be bypassed during flushing to prevent drain out from entering the system.
- (7) Under ultra-low temperature in winter, shutdown at night will cause the evaporator and pipeline frozen up, so it is highly recommended to add alcohol and propanol mixture in chilled water. Do not cut off the power supply when the unit is turned off, otherwise the freeze protection does not work. Alternatively, cut off the power supply and drain the water system thoroughly.
- (8) When the unit runs under the low load requirement, in order to avoid low load protection which would affect the service life of the unit, make sure the water capacity is more than 1/6 of total rated flow rate per hour of each module (for instance, for some project with four modularized LSQWRF60VM/Na-M units, if the rated water flow of each unit is 10.3m³/h, then the required capacity of the whole project should be larger than $10.3 \times 4 \times 1/6 = 6.87 \text{m}^3/\text{h}$). When the water course is quite short, a water tank is required; otherwise the service life of the unit would be affected.

△NOTE

Never use salt mixture to prevent the unit from being corroded.

■ How to install the water system

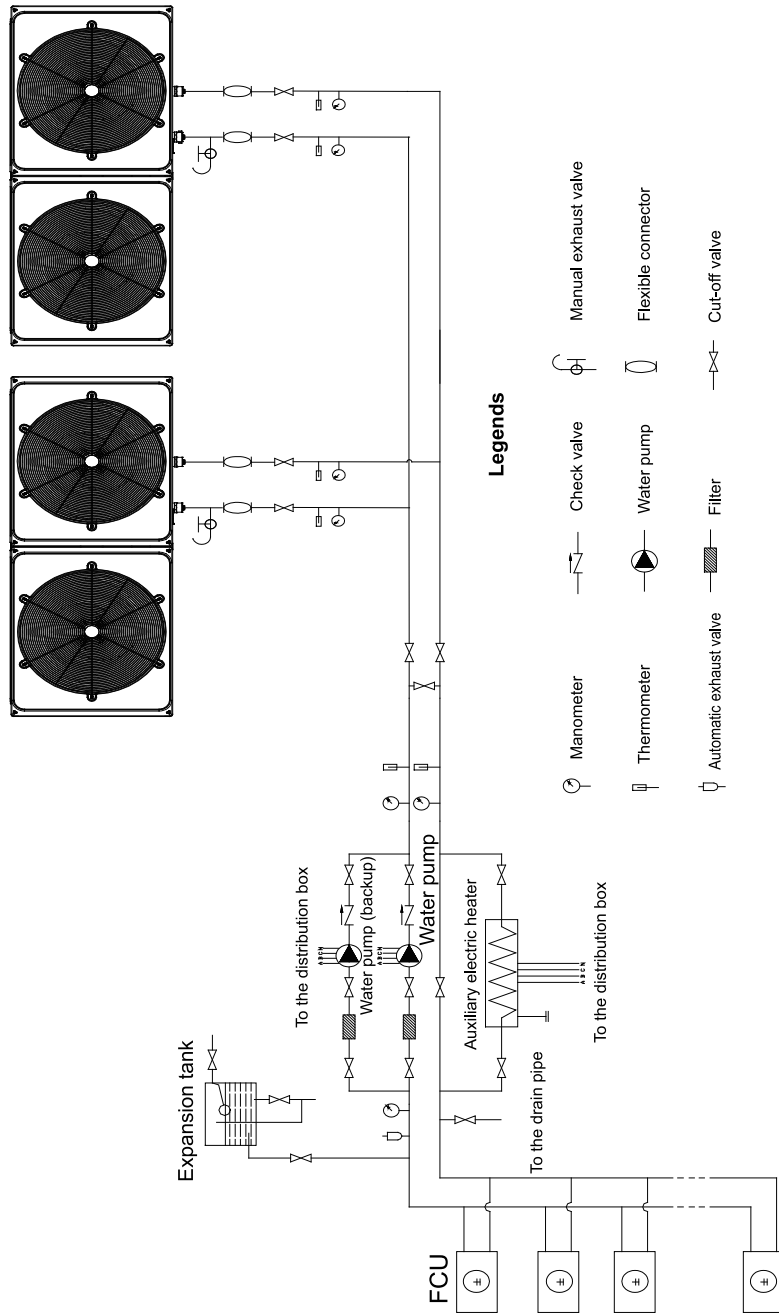

■ How to drain the water system :

- (1) Loosen screws around the panel and then take down it.
- (2) Remove anticlockwise the blind plug located at the bottom of the heat exchanger to let the chilled water flow out, after that, tighten the blind plug and reinstall the panel. (- Note: place the drainage equipment beneath the drain pipe to prevent pollution caused by the drain water.

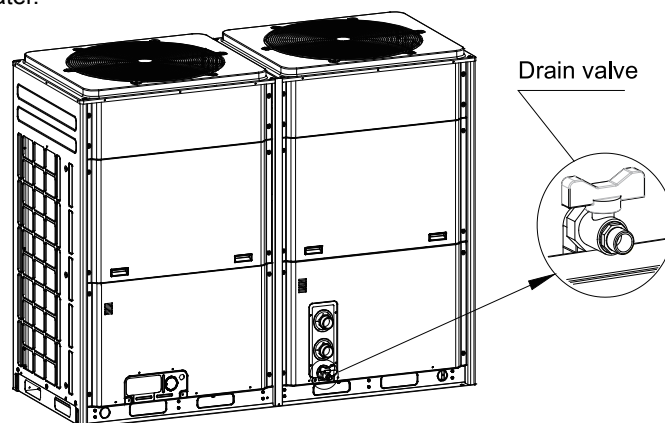

△ NOTE

Keep the purge valve of the water system open in order to drain the evaporator and condenser completely.

5.5.2 Requirements on Piping

- (1) The piping slope should meet design and construction regulations and the flexible pipe is not allowed to be longer than 150mm.
- (2) Pipes which go through the dilatation joint and the settlement joint should be protected with the flexible joint.
- (3) No matter which connection is used, welding, threaded connection or flange connection, the connection joint can't be in the wall, floor or sleeve pipe.
- (4) The riser pipe should be installed vertically. When the floor height is or less than 5m, a pipe clip is required. When the floor height is or larger than 5m, at least 2 pipe clips should be required. The installation height of the pipe clip is 1.8m. For the main riser pipe, it should be secured with the fixed bolster to support the weight of the riser pipe.
- (5) See the table below for the installation standards of the pipes.

Item		Allowable Deviation	Inspection Method
Straightness	DN≤100mm	2L‰ , max.440mm	By the ruler, tape measurement
	DN > 100mm	3L‰ , max.460mm	
Verticality		25L‰ , max.425mm	By the ruler, tape measurement
Interval of Parallel Pipes		15mm	By the ruler, tape measurement
Parallelism of Parallel Pipes		3mm	By the ruler, tape measurement

Piping Flowchart

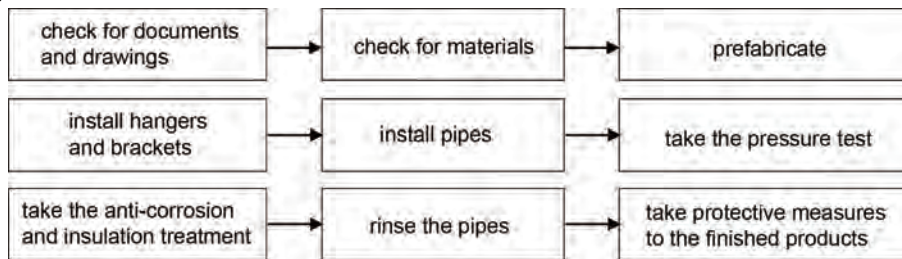

5.5.2.1 Check for Documents and Drawings

- (1) Check the process flow, construction procedures and quality requirements in accordance with drawings and technical data.
- (2) Check the installation location, installation height, arrangement, and installation space of pipes in accordance with equipment drawings and building drawings.

5.5.2.2 Check for Materials

- (1) Before installation, check for the mode of the valves, clean them and then take the strength and air-proof tests.
- (2) Pipes should be cleaned with a steel brush or abrasive paper. After that, seal the pipe ends and keep both the internal and external surface dry.
- (3) Pipes should be painted twice with anti-rust paint without any curtaining and voids.

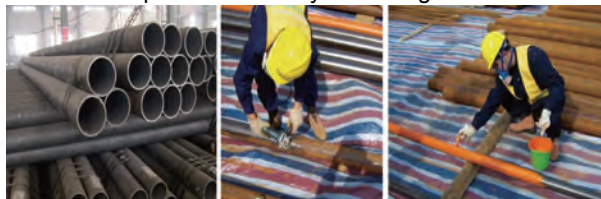

5.5.2.3 Prefabricating

- (1) Make out the installation drawing which clearly indicates the branch pipes, pipe diameter, reduced pipes, location of valves, installation dimensions etc. Then, prefabricate pipes in accordance with this installation drawing. Pipes should be processed with dedicated cutting machine, leaving no burrs at the pipe ends. After that, pipes should be cleaned to prevent sands and dusts from damaging the joint.
- (2) Pipe supports should be prefabricated in accordance with design requirements. The contact part between supports and pipes should be separated with wood blocks which has taken anti-corrosion treatment and is as thick as the insulation.



5.5.2.4 Installation of Pipe Brackets

- (1) The supporting beam should be fastened to the wall, pillar or other building structure. It should be placed horizontal horizontally with the top surface parallel with the center line of the pipe.
- (2) Pattern, installation, interval and standard height of supports for metal pipes should meet corresponding design requirements and codes.
- (3) Supports should be installed securely and contact the pipe closely. Separate supports are required at the connection joint between the pipe and the equipment.
- (4) Supports for chilled and cooling water pipes as well as main and branch pipes in the machine room should be anti-vibration. When a single-bar hanger is used, anti-vibration hangers should be set up every 15m and at the pipe ends, valves, tee joints and elbows.
- (5) See the table below for the interval of brackets.

Diameter (mm)		15	20	25	32	40	50	70
Max Interval between Brackets (m)	Insulated Pipe	1.5	2	2.5	2.5	3	3.5	4
	Non-insulated Pipe	2.5	3	3.5	4	4.5	5	6
Max Interval between Brackets (m)	Insulated Pipe	5	5	5.5	6.5	7.5	8.5	9.5
	Non-insulated Pipe	6.5	6.5	7.5	7.5	9	9.5	10.5

△ NOTE

It is applicable to the pipes with working pressure less than 2.0 and insulation density less than 200kg/m³ or without any insulation.



5.5.2.5 Installation of Pipes

Supply and return water pipes with the diameter of being or being less than DN 32 should be thread connected, and pipes with the diameter of being or larger than DN40 should be welded. Those which must be detachable should be flange connected. Before installation, foreign matters inside the pipe should be removed.



(1) Threaded Connection

- 1) Threads should be processed by the threading machine.
- 2) Use marnen as stuffing material and remove those outside of the threads after pipes have been installed.
- 3) Threads should be clean and at least 90% threads should be intact. Exposed threads at the connection joint after installation should be 2-3 without any exposed stuffing. Galvanized pipes should be protected and local damage should take anti-corrosion treatment.

(2) Welding

1) See the table below for types and sizes of grooves for welding which should be processed by the facing machine.

Table 5.5.1 Types and Sizes of Grooves for Welding

Item	Thickness	Type	Groove			Remarks
	T(mm)		Clearance	Shoulder	Angle (°)	
			C(mm)	P(mm)		
1	1 ~ 3	I-shaped		0.1 ~ 1.5	—	—
	3 ~ 6 Double Welding			1 ~ 2.5		
2	6 ~ 9	V-shaped		0 ~ 2.0	0 ~ 2.0	65 ~ 75
	9 ~ 26			0 ~ 3.0	0 ~ 3.0	55 ~ 65
3	2 ~ 30	T-shaped		0 ~ 2.0	—	—

- When pipes with the same diameter and thickness are butt connected, their inner walls should be aligned within a deviation of 1/1000. Length of the groove for welding can't be larger than 10mm.
- The groove for welding should be as far as away from the unit and should not be parallel with the center line of the equipment interface. The welding seam should keep a distance of at least 50mm with the hanger and bracket.
- Welding should be done by the qualified welder. In welding, there should be a wind, rain, or snow guard. The environmental temperature for welding can't be lower than -20°C. A 250mm groove for welding should be preheated to 100°C.
- The welding height can't be lower than the surface of the parent metal. There should be no crack and poor welding at the welding seam and the heat-affected zone. There should be no slag inclusion, crater and pore at the welding zone.
- Distance of two neighboring butt-jointed seams should be no less than the external diameter of the pipe and can't be less than 180mm. No butt-joint seam is allowed at the elbow. The welding seam should keep a distance of at least the external diameter of the pipe from the elbow and can't be less than 100mm. No branch pipe is allowed to be welded at the elbow and welding seam. The hanger and bracket should keep a distance of at least 80mm with the welding seam.

7) Reinforced Height

h(mm)

Surface of the welding seam should be cleaned and be visually inspected. Quality of the welding seam should meet requirements listed the table below.

Table 5.5.2 Reinforced Height and Width of the Welding Seam

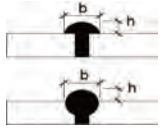
Welding Seam	Pipe Thickness (mm)		2 ~ 3	4 ~ 6	7 ~ 8
		Without grooves	Reinforced Height h(mm)	1 ~ 1.5	1.5 ~ 2
Width b(mm)			5 ~ 6	7 ~ 9	-
With grooves		Reinforced Height h(mm)	-	1.5 ~ 2	2
		Width b(mm)	About 2mm over the groove		



(3) Flange Connection

- The flange should keep vertical with the center line of the pipe. Flange screws should have the same length and same direction. Length of the bolt out of the nut should be a half of the diameter of the bolt
- Flange screws should be fastened along the diagonal to form an even seam.
- The flange is not allowed to be directly welded to the elbow but used for the straight pipe at least 100mm long.
- When a flange is connected with another, they should match each other naturally to avoid pipes or equipment from producing extra stress.

- 5) The flange at the branch should keep a distance of at least 100mm from the main pipe, and the flange at the thru-wall pipe should keep a net distance of at least 200mm with the wall.
- 6) When a flange is connected to the unit, a wash should be placed at the center of the flange without any deviation. Except for design requirements, do not use dual-layer, multi-layer, or tilted washers.



5.5.2.6 Installation of Valves and Water Filters

- (1) Installation location, height and direction of valves should be correct. And they should be arranged orderly within a deviation of 3mm in the same plane.
- (2) The valve stem can't be downward but toward the direction which will facilitate its operation.
- (3) Attention should be paid to the arrow which indicates the direction of fluid in the valve.
- (4) Installation of electric valves and solenoid valves should be guided by electricians. They should be commissioned prior to installation.
- (5) The water filter is usually installed at the inlet pipe of the water pump and other equipment. Pay attention to the water flow direction.
- (6) The automatic exhaust valve should be installed at the highest point of the system. In order to facilitate maintenance, a gate valve should be installed upstream of the automatic exhaust valve.
- (7) A drain pipe or drain valve should be installed at the lowest point of the water system. For the closed-circuit system, an exhaust valve should be installed at the highest point of the system and where a large amount of air may be trapped.
- (8) The water filter should be installed at the inlet pipe in correction direction and easily be cleaned. Material of the filter screen should meet the design requirements.



5.5.2.7 Pressure Test

The pressure test includes single item pressure test and whole system pressure test. The former is done when the main pipes or concealed pipes have been installed. The latter is done when all main pipe and riser pipes have been installed. The pressure test should be taken prior to the insulating procedure and done in accordance with the following statement.

- (1) The pressure test should be done one section by another. The manometer should be installed at the lowest point of the testing pipes.
- (2) Water should be charged from the lowest point. During charging, close all inlet valves and drain valves, but open the manifold valve and each valve at the branch pipes. During the pressure test, it can't be put into normal use. Special attention should be paid that the exhaust valve should be opened until air inside the system is removed completely.
- (3) For the heat pump system, when the working pressure is or less than 1.0MPa, the test pressure should be 1.5 times of the working pressure but no less than 0.6MPa; when the working pressure is larger than 1.0MPa, the test pressure is the working pressure plus 0.5MPa.



- (4) Raise the pressure to the test pressure and the test pressure should be kept for 10 minutes. Then, lower the pressure to the working pressure and the working pressure should be kept for 60 minutes. No leakage through the visual inspection indicates it is satisfactory.
- (5) The filling water test is taken for the condensate water system. No leakage through the visual inspection indicates it is satisfactory.

5.5.2.8 Anti-corrosion and Insulation

- (1) Anti-corrosion: supply water and return water pipes, branch pipes, and pipe brackets should be painted with anti-rust paint twice. The damaged galvanized condensate pipes and pipes with exposed thread also should be touched up with anti-rust paint.



- 1) Pipes should be painted evenly and the paint thickness should meet relative requirements.
- 2) Pipes should be painted without curtaining and holidays.

- (2) Insulating: PEF ($\delta=30\text{mm}$) is taken as the insulating material.

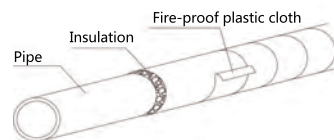

- 1) The insulation should be arranged evenly and smoothly.
- 2) Flanges should be insulated separately.
- 3) Seams of the insulation should be airtight.



- 4) Insulation for the stainless iron sheet should be smoothly and the seams should be airtight.
 - 5) Flanges should be insulated separately.
 - 6) Seams of the iron sheet should be at the downstream of the drain water.
- (3) **Note:** for the riser pipes, when the floor height is or less than 5m, there should be a bracket tray for each floor; when the floor height is larger than 5m, there should be at least two bracket trays 200mm ahead of the riser pipes. The diameter of the bracket tray can't be larger than the thickness of the insulation. Expansion seams should be left for the insulation of the brackets. A 5mm expansion seam should be left every 5-7m on the branch pipes. Also 30mm seams should be left for elbows. Clearance between the insulation and the pipe sleeve should be stuffed with non-inflammable material.



- (4) Pipes should be labeled with legible fonts and the direction of the fluid. The paint color should be selected properly. Once color circles are used, their intervals should be even. Labels listed in parallel should be arranged reasonably.



- 1) The typeface on the label matches with the diameter of the pipes.
- 2) The label indicates the name and direction of the fluid.
- 3) The label is eye-catching and struck reliably.

5.5.2.9 Cleaning of Pipes

After the pressure test, the system should be rinsed one section by another with the maximum allowed flow or the flow no less than 2m/s until leaving water is as clean and transparent as entering water. For the heat pump system, it can be put into normal use until it has been rinsed (leaving water is as clean and transparent as entering water.) and has taken a trial run for about 2 hours.



5.5.2.10 Protection for the Finished Product

- (1) Prefabricating, anti-corrosion treatment, setup, and pressure test procedures go closely one by once. If interrupted, the open mouth of pipes should be closed to prevent foreign matter entering.
- (2) Installed pipes can't be taken as the lifting center, and also can't be stepped on.
- (3) Pipe repair should be finished prior to external decoration and do not damage any wall and floor finished product after external decoration.
- (4) During external decoration, installed pipes, valves, gauges etc. should be guarded by appointed personnel to prevent them from being damaged in other construction procedure.

5.5.3 Installation of the Expansion Tank

An expansion water tank should be installed for the closed-circuit water system to buffer water expansion and constriction as well as avoid effects on the water pipes caused by makeup water.

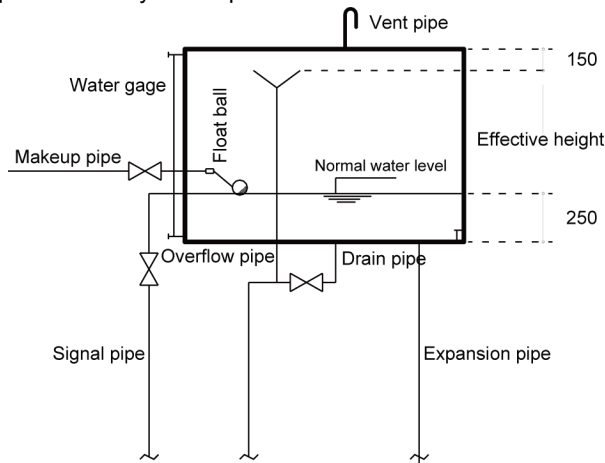

- (1) After the full water test, surface of the water tank should be de-rusted, finished and treated with ant-corrosion measure. The artificial anti-rust class should be st3.
- (2) After that, when water tank temperature is below 30°C, it should be painted with red lead rust-proof paint twice. When the temperature is among 30 ~ 70°C, it should be painted with chloroethylene 4~5 times. When the temperature is among 70 ~ 95°C, it should be painted with heat-resistant anti-rust paint 4~5 times. Do not do directly welding on the water tank with surface treatment.
- (3) The water tank should be installed horizontally and placed at a bar support which should go 100mm beyond at each side of the base plate. Height of the bar support should be no less than 300mm.

- (4) When water pipes are installed in the room without the heating system, the water tank, expansion pipe, circulating pipe, and signal pipe all should be insulated.
- (5) The installation height of the expansion water tank should be in the way that the lowest level of the water tank is at least 1m above the highest point of the water system.
- (6) For the mechanical circulating air-to-water system, in order to keep the expansion water tank and water system run normally, the expansion pipes of the expansion water tank should connect to the suction inlet of the circulating water pump. For the gravity circulating system, the expansion pipes should connect to the top of the main supply water riser pipe.
- (7) For the two-pipe air conditioning system, when there is only one expansion water tank for cold and hot water, its effective volume should be figured out based on the heating conditions.
- (8) When the water tank is or higher than 1500mm, it should have ladders both inside and outside of the water tank. When the water tank is or higher than 1800mm, it should have two glass gauges to indicate the water level.
- (9) The circulating pipe should be connected to the main return pipe. Horizontal distance between the connection point to the constant-pressure point should be no less than 1500~3000mm.

5.5.4 Installation of Condensate Pipes

Setup-Insulating-Fastening

△ NOTE

- (1) Adverse slope is not allowed for the slope larger than 1%.
- (2) It can't connect with the rain water pipe, sewage pipe or other pipes.
- (3) The elbow ventilator should be installed at the highest point of the condensate pipe to prevent foreign matters coming into the drain pipe.
- (4) The S-shaped trap and flexible joint are necessary.
- (5) The diameter of the pipes should be suitable.
- (6) The wall-thru or floor-thru pipes should be protected by the steel sleeve. Do not put seams inside the sleeve. The steel sleeve should keep flush with floor, or 20mm above the floor for the floor-thru pipes. The steel sleeve is not allowed to affect the slope of the pipe and can't be used as the support of the pipe. Clearance between the pipe and the sleeve should be stuffed by flexible non-inflammable material.

5.5.4.1 Setup

The condensate pipes should be at least 300mm away from the electric box of the unit. For special space, its installation location should be approved by the corresponding designers.

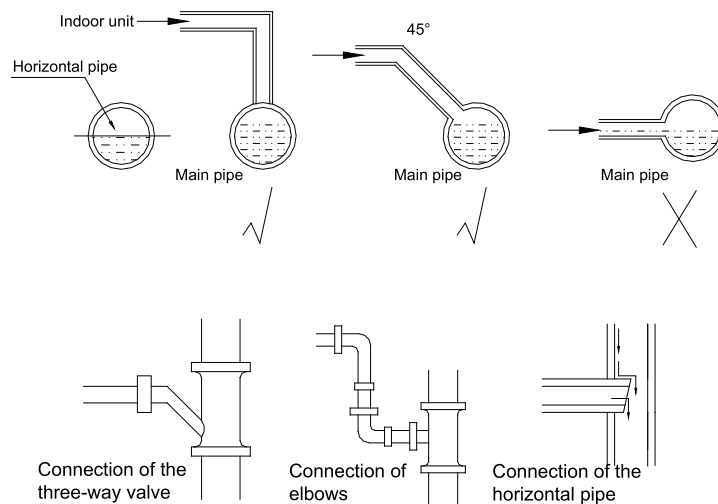

Figure 5-1 Connection of the Main Pipe and the Branches

When the three-way valve is used for the condensate pipe, its straight two connectors should be kept at the same level as shown in the right figure.

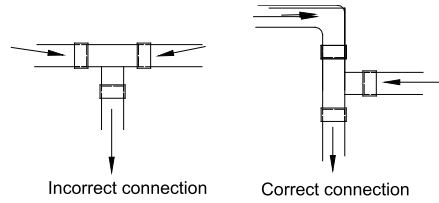

Figure 5-2 Tee Joint

When there are several indoor units at the same floor, their condensate is usually drained out through one main pipe. In this case, the branches pipe for each unit should be located higher than the main pipe. The size of the condensate pipe is determined by the capacity and number of the indoor units.

Size of the tee drain pipe should match with the running capacity of the unit.

As pressure at the water outlet is quite large, a water trap is required for the drain pipe, which is applicable to the horizontal type air handing units and the indoor units of the duct type air conditioners.

$$A=P+25\text{mm}$$

$$B=P/2+25\text{mm}$$

P indicates the mmH₂ corresponding to the passive pressure.

The pipe diameter should be or larger than 32mm

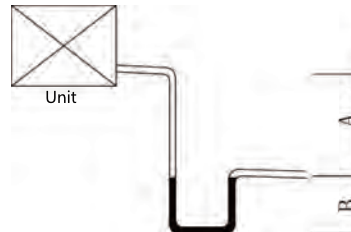
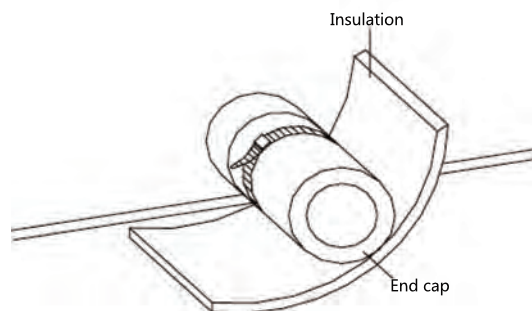

Figure 5-3 Water Trap

5.5.4.2 Insulating

The extended drain pipe should be insulated and special care must be paid to the elbows. See the table below for the thickness of the insulation.

Drain Pipe(mm)	Thickness of Insulation (mm)
All	≥15



Insulation should be thickened at humid areas.

5.5.4.3 Fastening

The insulating tube is just required to be bundled and fastened at the supporting bracket.

5.6 Electric Wiring

5.6.1 Safety Precautions



- (1) The electricians should be licensed.
- (2) The air conditioning is Class I appliances and should be grounded reliably.
- (3) The grounding resistance should comply with the national standards covered in GB 50169
- (4) The yellow-green line is for grounding. Do not use it for other purpose or cut it off or fixed with the self-tapping screw, otherwise it would lead to electric shocks.
- (5) The power supply should be reliably grounded and do not connect the grounding line to a) running water lines; b) gas lines; c) blow-off lines; d) other unreliable places.
- (6) Do not make the power lines and communication lines entwined and arrange them separately with a distance no less than 20cm, otherwise it would lead to abnormal communication.
- (7) Do not wire improperly power lines and communication lines. When the power line is wired to the communication port, it would make the main board burnt out.

5.6.2 Control Concept

5.6.2.1 External Wiring of the Electric Control Cabinet

■ LSQWRF35VM/NaA-M, LSQWRF60VM/NaA-M, LSQWRF65VM/NaA-M

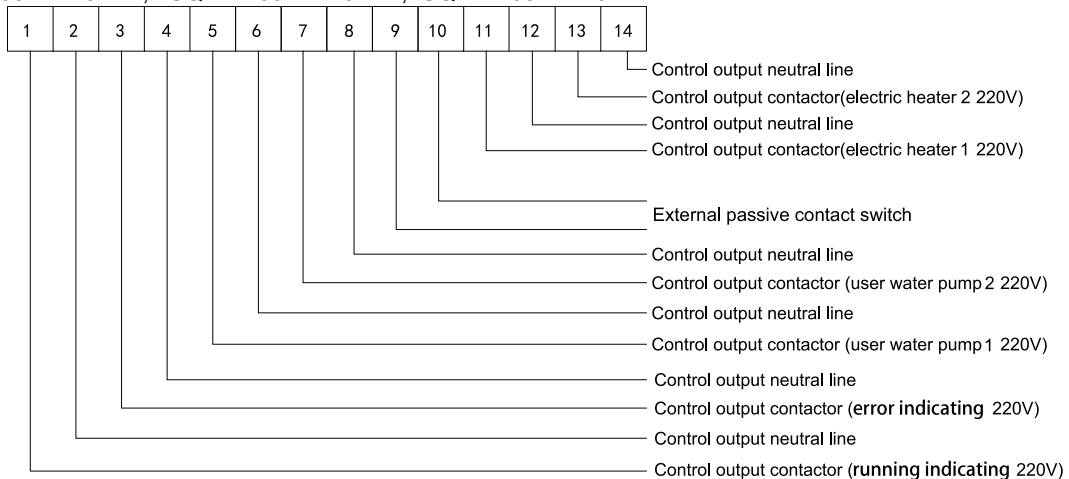

Note: the output control lines of the AC contactors for the running indicator, water pump 1, water pump 2, auxiliary electric heater 1, auxiliary electric heater 2 can be wired to the corresponding wiring board of any one unit, while those for the error indicator and external passive contact switch should be wired to the corresponding wiring board of all units as shown in the figure below.

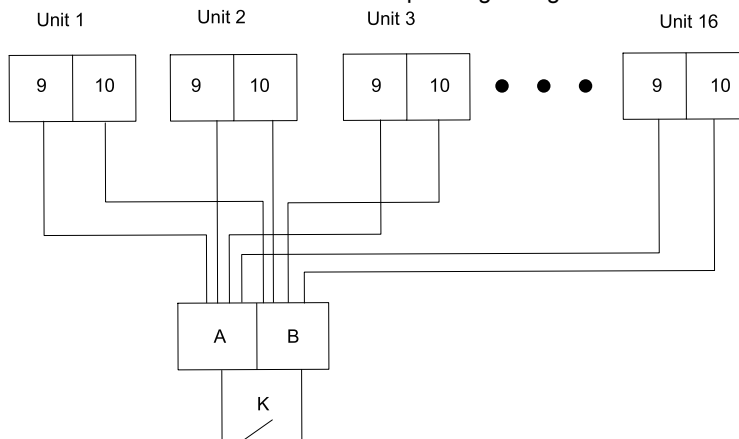

When external passive contact switch is available for multiple units, the wiring board 9 and 10 of each unit should be wired to the dry contact A and B.

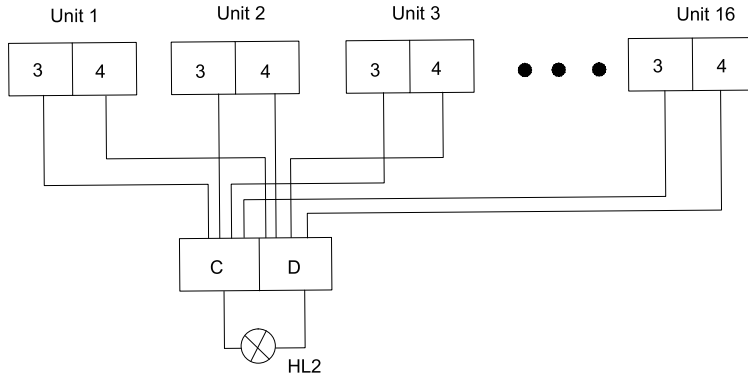

When it is required to display errors of several units, the wiring terminals (3, 4) of each unit should be wired to the wiring terminals HL2 (C, D) of the error indicator.(If it is required to display the error of each unit independently, then the error indicator of each unit should be wired independently to the corresponding error output wiring terminals (3,4) of each unit.)

5.6.3 Specification of Power Cord and Air Switch

See the table below for selection of the power lines and the air switches.

Model	Power Supply	Min. sectional area of the power cable (mm ²)			Capability of the Air Switch Live (A)
		Live Line	Neutral Line	Earth Line	
LSQWRF35VM/NaA-M	380V ~ 415VAC 3Ph 50Hz	6	6	6	32
LSQWRF60VM/NaA-M	380V ~ 415VAC 3Ph 50Hz	16	16	16	63
LSQWRF65VM/NaA-M	380V ~ 415VAC 3Ph 50Hz	16	16	16	63

Notes:

- (1)The specifications of the breaker and power cable listed in the table above are determined based on the maximum power (maximum amps) of the unit.
- (2)The specifications of the power cable listed in the table above are applied to the conduit-guarded multi-wire copper cable (like, JYV copper cable, consisting of PV insulated wires and a PVC cable jacket) used at 45°C and resistible to 90°C(GB/T 16895.15-2002). If the working condition changes, they should be modified according to the related national standard.
- (3)The specifications of the breaker listed in the table above are applied to the breaker with the working temperature at 40°C. If the working condition changes, they should be modified according to the related national standard.

5.6.4 Wiring of the Electric Control Cabinet

■LSQWRF35VM/NaA-M,LSQWRF60VM/NaA-M, LSQWRF65VM/NaA-M

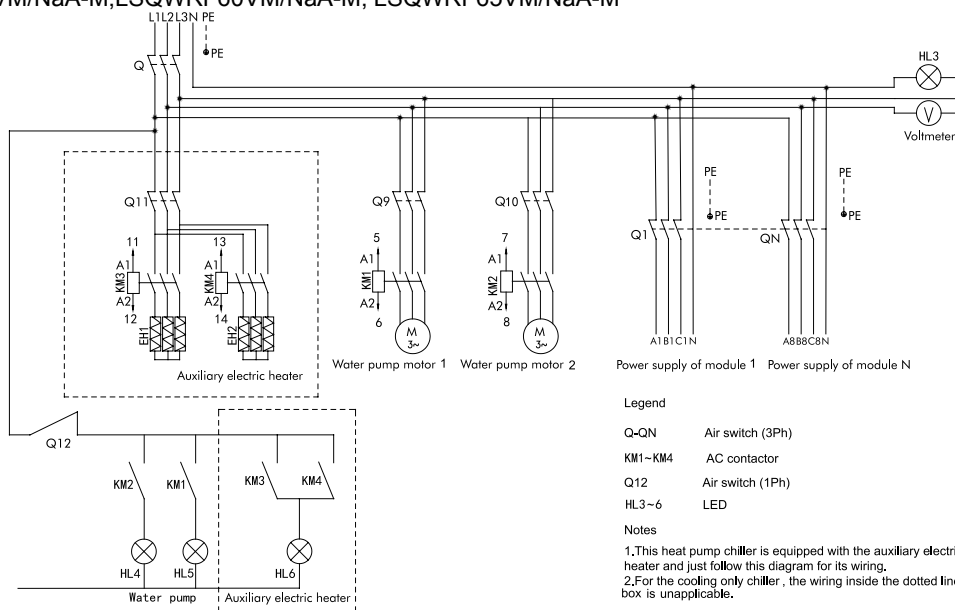

Legend
 Q-QN Air switch (3Ph)
 KM1-KM4 AC contactor
 Q12 Air switch (1Ph)
 HL3-6 LED

Notes
 1.This heat pump chiller is equipped with the auxiliary electric heater and just follow this diagram for its wiring.
 2.For the cooling only chiller, the wiring inside the dotted line box is unapplicable.

5.6.5 Filed Wiring

■Safety Codes

- (1)All wiring shall comply with applicable codes and engineering requirements.

- (2) All field wiring shall be performed by the qualified electrician.
- (3) Never perform wiring before the power supply is cut off.
- (4) Any damage caused by the improper external wiring shall be at the installer's expense.

⚠ WARNING

Only copper conductor is allowed.

■ How to wire the power lines to the electric box

- (1) The power cord must be routed inside the conduit.
- (2) The power cord must enter the electric box through a rubber or plastic ring to avoid any damaged caused by the sharp edge of the metal sheet.
- (3) The power cord close to the electric box must be attached securely to prevent the terminal block of the electric box affected by the outside force. The Power cord shall be installed with a suitable cord anchorage against cord loosening. See the wiring diagrams below for external wiring.

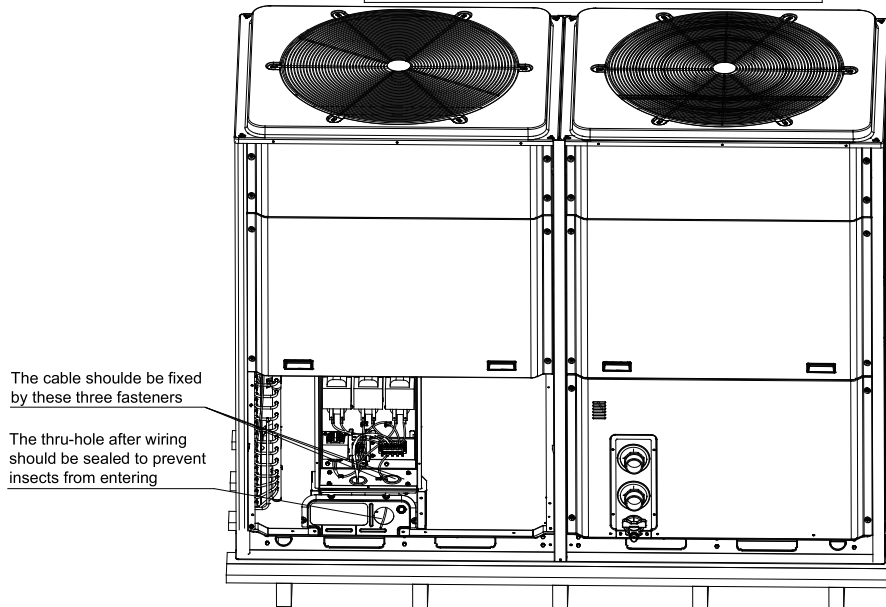
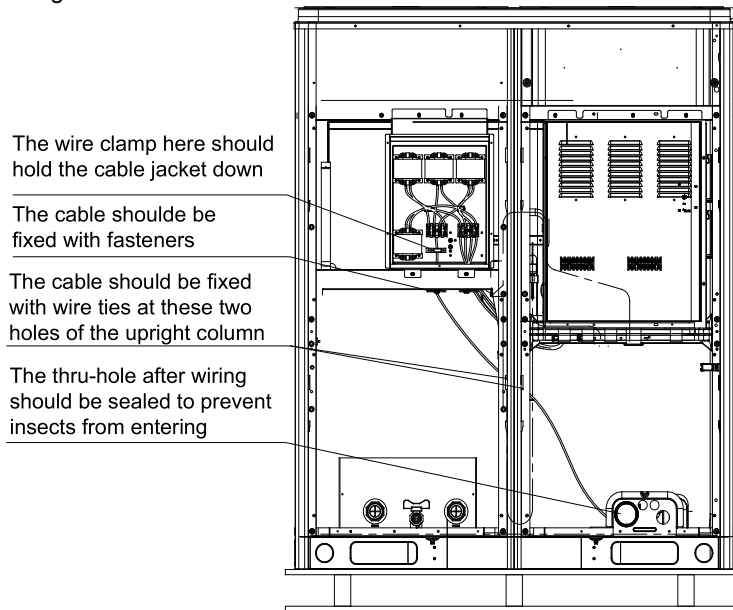

LSQWRF35VM/NaA-M

LSQWRF60VM/NaA-M,LSQWRF65VM/NaA-M

- (4) The unit shall be grounded reliably and never connect the ground wire with the gas fuel pipe, water pipe, lightning rod or telephone line.
- (5) After wiring, O-rings should be tightened to prevent coming of insects.

■ Control Line

- (1)The field supplied control line shall be at a minimum 1mm².
- (2)The electric box will send the control signal (220 AC, 5A) to control the chilled water pump and auxiliary electric heater, however, never do not drive them directly through the control signal but through their AC contactors.
- (3)Switching signals (220VAC, 2A) for the running and error indicators are available for the electric box.
- (4)The remote switch control signal is available for the electric box and please pay attention to the input passive dry contact.
- (5)A reasonable length of the control line should be left outside the unit and the rest should be bundled and fed into the electric box.
- (6)The connection line of the display panel and main board is reliably grounded through the main board. Beside, communication lines between units also should be grounded.

5.6.6 Networking and Wiring between Units

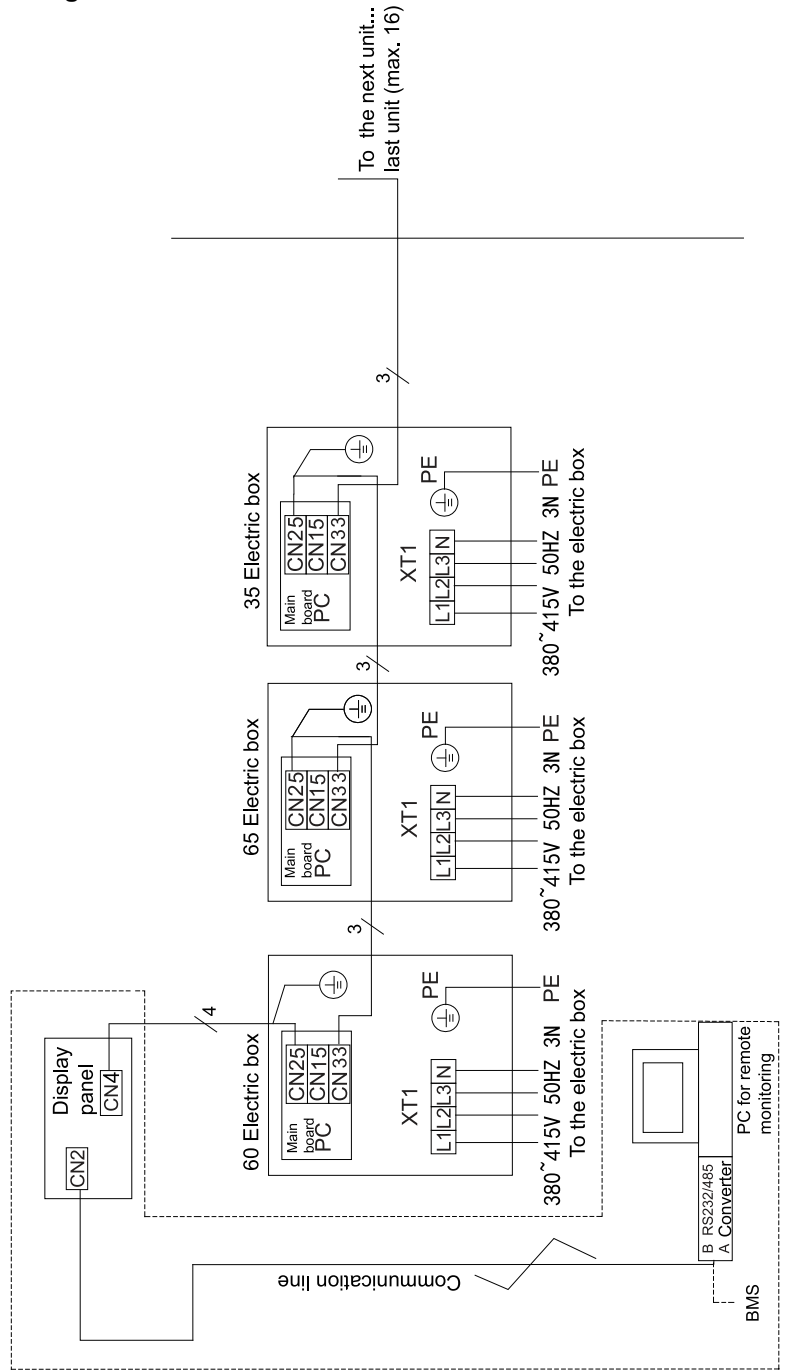

Notes

- (1)As shown in the diagram above, CN33 and CN25 of all modules are connected by a three-core four-pin shielded communication line whose ground wire will be linked to the terminal near the main board.
- (2)As shown in the diagram above, CN4 on the display panel is connected to a CN25 on a main board of any unit by a four-core four-pin shielded communication line whose ground wire will be linked to the terminal near the main board.

- (3) The power lines should be connected to L1, L2, L3, and N at XT1 through a piece of four-core rubber sleeve cable as shown in the figure above.
- (4) There are two solutions for remote monitoring.
- 1) Install the remote monitoring software at the PC.
 - 2) Based on GREE provided Modbus protocol, the user can do second development to this protocol.

Note: those enclosed by the dotted lines indicate the remote monitoring equipment. When the quantity of the display panel exceeds 30 or length of the communication line exceeds 800m, extra photoelectric relay is required. The photoelectric relays, communication lines (class 5 twist pairs), converters are optional. PC should be prepared by the user themselves.

5.6.7 Electric Wiring Diagram

■LSQWRF35VM/NaA-M

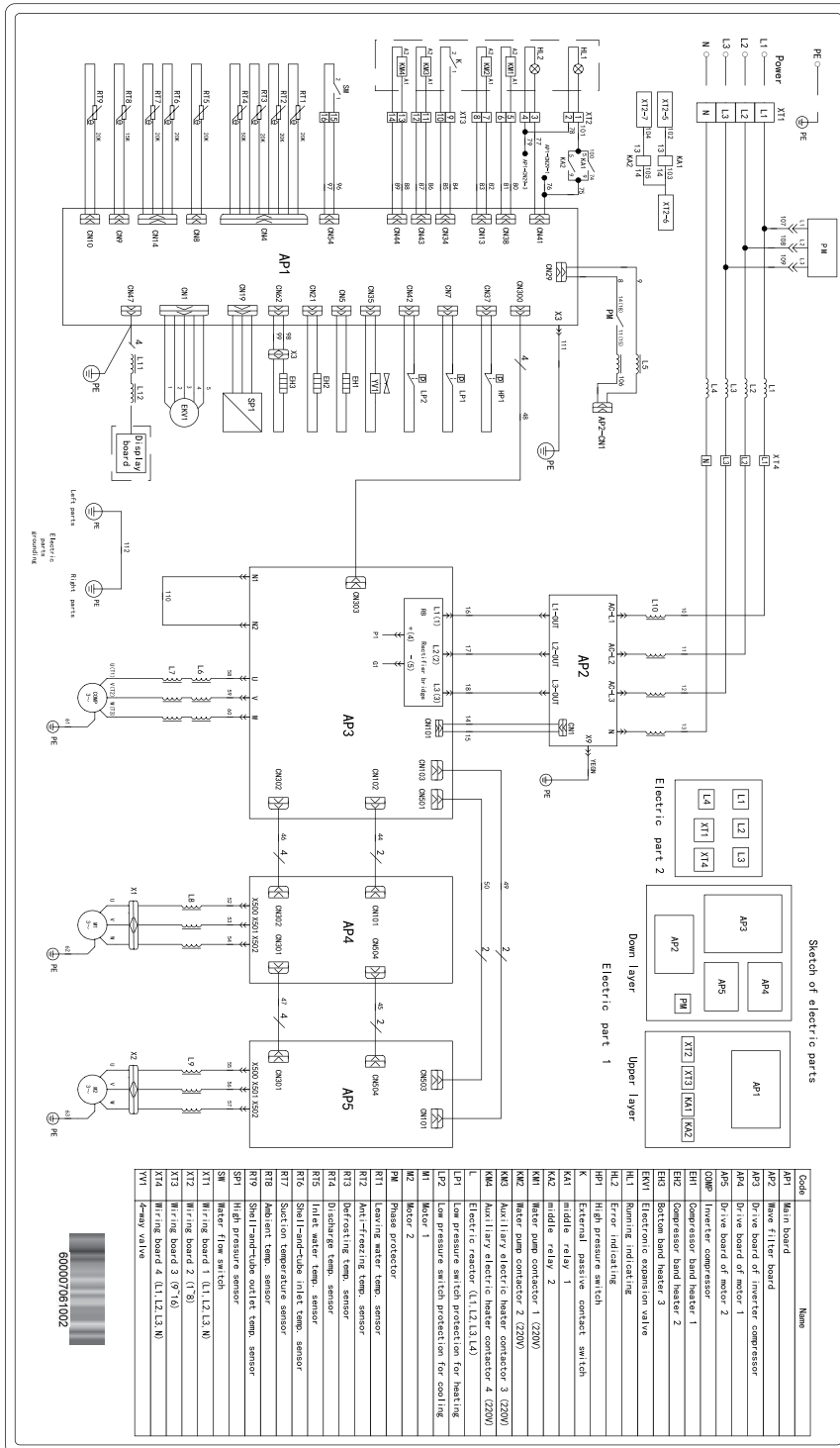

■LSQWRF60VM/NaA-M, LSQWRF65VM/NaA-M

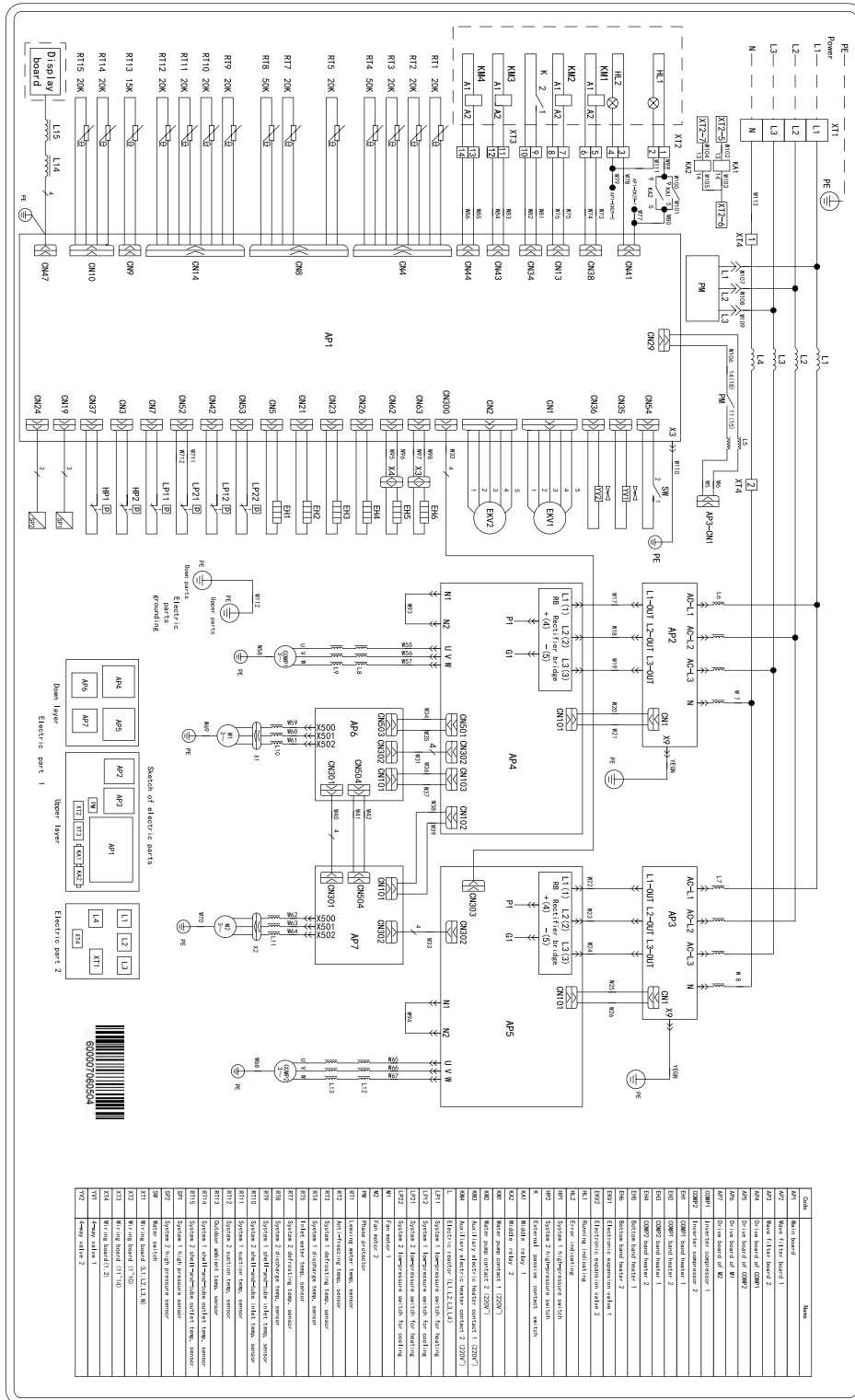



The electric wiring diagram stuck to the main body of the unit always prevail.

5.6.8 Jumpers

When it is required to replace the main board, be sure the main board can match with the applicable jumpers.

Table 5.6.1 Jumpers List

Model	Code	Jumper No	Matched Compressor
LSQWRF35VM/NaA-M	4202021905		QXAS-H80zN345H
LSQWRF60VM/NaA-M	4202021907		QXAS-H80zN345H
LSQWRF65VM/NaA-M	4202021906		QXAS-H80zN345H

6 Commissioning

6.1 Flowchart of Commissioning

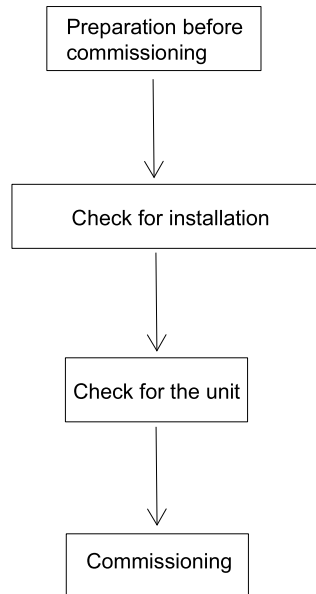

6.2 Safety Precautions for Commissioning

⚠ WARNING





- (1) Safety measures should be taken during indoor operation. Any commissioning and service men should grasp and observe safety regulations of construction work.
- (2) Refrigeration mechanic, electricians, welders and other technicians of other special work all should be licensed.
- (3) Power supply should be cut off before any operation to the unit. Meanwhile, please observe required safety operation.
- (4) All installation and operation should comply with design requirements of this product and local safety requirements.
- (5) Never force the compressor to run by electrifying it directly.





6.3 Preparation before Commissioning

6.3.1 Documents

- (1) Manual of installation instructions
- (2) Certificate of qualification
- (3) Electric wiring diagrams
- (4) Sheet of saturated temperature and pressure

6.3.2 Tools

Name	Image	Name	Image
Pressure gauge		Digital volt-ohmmeter	
Spanner		Clip-style ammeter	

Name	Image	Name	Image
Phillips screwdriver		Leak detector	
Straight screw driver		Megohmmeter	

6.3.3 Check before Commissioning

6.3.3.1 Completeness Check to the Main Unit

Is the surface of the unit in good condition?

Is there leak at any pipe connector?

Is any part damaged?

6.3.3.2 Check to Installation of the Unit

Does the installation location, installation foundation and maintenance space comply with corresponding requirements?

6.3.3.3 Check to the Water System

(1) Is the water flow direction in the condenser and evaporator correct?

(2) Are the chilled water pipes clean? Is there any foreign matter trapped in the joints? Is the water quality satisfactory?

(3) Is the insulation of the chilled water pipes in good condition?

(4) Are the manometer and thermometer connected correctly (Is the manometer at a right angle with the water pipe, and is the thermometer's probe inserted into the water pump)? Do the initial values of the manometer and thermometer comply with requirements before commissioning?

(5) Is the leaving water flow switch installed correctly? Is this flow switch correctly wired to the electric control cabinet?

(6) Start the chilled water pump through the contactor and see: does the chilled water pump run in the correct direction (-clockwise)? If not, check the wiring of the water pump.

(7) Run the chilled water pump and see: is the water pressure stable? do the reading values of water pressure change slightly? Is the running ampere in the rated range? If not, figure out and eliminate the causes.

(8) Does the water makeup device of the expansion water tank work well? Does the automatic exhaust valve work well? For the hand exhaust valve, open it to exhaust air inside the system.

6.3.3.4 Check to Work Load

(1) Are the air handling units connected correctly?

(2) Do all diffusers work smoothly?

(3) Are the tightness and insulation of the conditioned space in good condition?

(4) Does the required load match with the capacity of the unit?

6.3.3.5 Check to the Electric System

⚠ WARNING

(1) Do not check the power supply without any proper detection device and preventive measures, or it would lead to severe injuries or even death.

(2) Each single unit should be supplied with dedicated power lines. After wiring, check the following items one by one.

1) Is the size of the air switch proper?

2) Does all electric installation meet corresponding electric standards or codes?

3) Is all wiring correct?

4) Are all interlocks work well?

5) Do all contacts work well?

6) Are the power supply and insulation in good condition?

7) Is the set point of the control and protection elements correct?

6.4 Initial Run

Following inspections above, the unit is allowed for initial run.

6.4.1 Check for Initial Run

Check for initial run should be performed by four steps as shown below.

6.4.1.1 Check for Communication

Check if the displayed number of modules is the same as the real number. If so, it indicates communication goes normal. If not, take the following inspections.

- (1) Are all connected units powered on?
- (2) Does each single unit have a unique address?
- (3) Is there any single unit which has not been detected by the control? Is the communication line of the mainboard connected correctly or is the communication line itself non-defective?

6.4.1.2 Check for a Single Unit

- (1) Commission one single unit first and stop all others.
- (2) Do its compressor, fans and the 4-way valve run normally without any unusual noise?
- (3) Is the voltage phase difference lower than $\pm 2\%$?
- (4) Voltage phase difference = $(\text{Phase difference between the max and average voltage}) / (\text{Average voltage}) \times 100\%$.
- (5) Start up this single unit.
- (6) Do its compressor, fans and the 4-way valve run normally without any unusual noise?
- (7) Check other units one by one in the same way.

6.4.1.3 Check for the Water Flow of a Single Unit

In order to prevent the water temperature changing too quickly, it is suggested to open all terminal units in commissioning, and observe and record the pressure drop of the manometers at the outlet and inlet pipes. Also, adjust the flow control valves or shut-off valves to make the flow meet application requirements.

When the environmental temperature is available, let the unit perform cooling ($>15^{\circ}\text{C}$). When the unit has run stably for 10 minutes, the normal difference of the entering and leaving water should be $4-6^{\circ}\text{C}$.

- (1) If the temperature difference is larger than $4-6^{\circ}\text{C}$, raise it by reducing the water flow of other units.
- (2) If the temperature difference is smaller than $4-6^{\circ}\text{C}$, ignore it in the event that the difference of other units is suitable, and reduce the water flow of this unit in the event that the difference of other units is also unsuitable.
- (3) Check for the water flow of other units one by one in the same way.

6.4.1.4 Check for Operation of the Whole Unit

- (1) Check the difference of the entering and leaving water temperature of each unit when the whole unit has been in operation. If temperature adjustment fails, reconsider the capacity of the selected water pump.
- (2) Start up the whole unit under the full load. When the whole unit has run stably for one hour, check if the water temperature and the air conditioning effect meet the user's requirements.
- (3) Observe and record the entering and leaving water temperature, condensing and evaporating pressure. Then, stop the unit and check the set point of each parameter on the control panel. After that, complete the commissioning data sheet.
- (4) When the unit goes into the protection state, figure out causes as well as solutions.

7 Repair

7.1 Error List

Error Name	Error Source	Protection Logic
High-pressure protection	High-pressure protection	When the pressure is too high or the current exceeds the set point, the corresponding compressor will stop and the indicating LED on the control panel will light on and the error information will be displayed on the error log which must be manually cleared for normal operation of next time.
Low pressure protection	Low pressure protection	When it is detected the low-pressure switch of the compressor is opened frequently, the compressor will be shut down immediately. Meanwhile, the error information will be displayed among the error log which must be manually cleared for normal operation of next time.

Error Name	Error Source	Protection Logic
High discharge protection	Discharge temperature sensor	When it is detected that the discharge temperature exceeds the set point, the compressor will be shut down immediately. Meanwhile, the error information will be displayed among the error log which must be manually cleared for normal operation of next time.
Temperature sensor protection	Temperature sensor	When the entering water temperature fails, all compressors and fans of the corresponding single unit will stop. When the discharge temperature sensor fails, the display panels will tell "Discharge temperature sensor X error". In this case, the unit can be started normally only when it has been unlocked. When the antifreeze temperature sensor or leaving water temperature sensor fails, the display panel will display this error. In this case, the unit can resume normal operation only when this error has been cleared manually.
Communication error	Main board	When the single unit fails to receive signals from the control panel, it will automatically be shut off.
Phase loss/reversal protection	Phase protector	When phase loss/reversal occurs, the phase protector will cut off the power supply to the main board.
Protection for the water flow switch	Contact	When a single unit detects its flow switch is open, this module will automatically be shut down. When all flow switches are closed, the water pump will stop.
Protection for the four-way valve	Entering and leaving water temperature sensor	When it is detected that the entering water temperature is 4°C higher than the leaving water temperature and the latter continuously goes down, the compressor will be stopped immediately and the control panel will display this error.
Protection for the compressor IPM module	Drive board of the compressor	When it is detected that the compressor IPM current or temperature is higher than the set point, the compressor will be stopped immediately and the control panel will display this error.
Protection for the fan IPM module	Drive board of the fan	When it is detected that the fan IPM current or temperature is higher than the set point, the compressor will be stopped immediately and the control panel will display this error.

7.2 Flow Chart of Troubleshooting

(1) High pressure protection

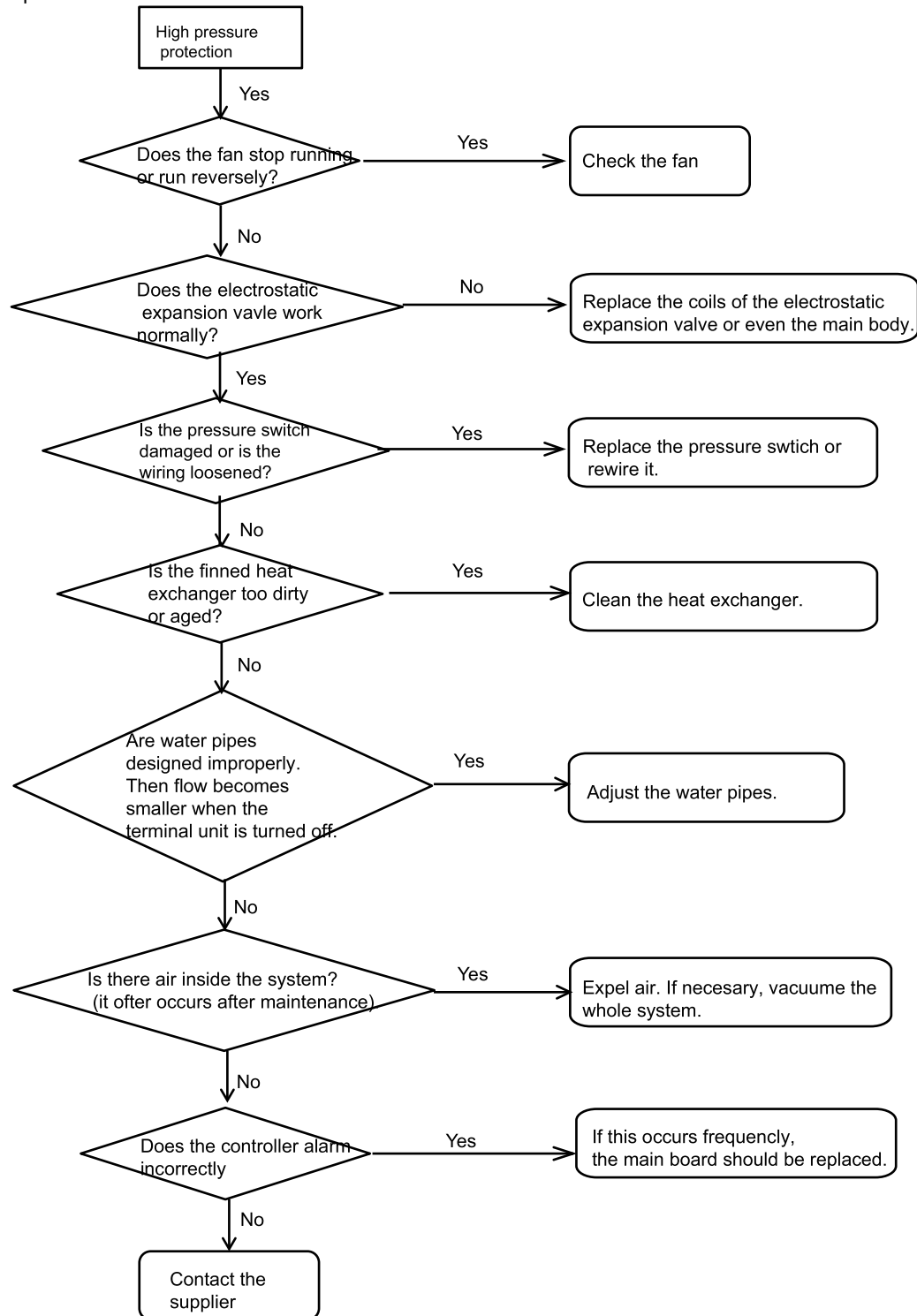

(2) Low pressure protection

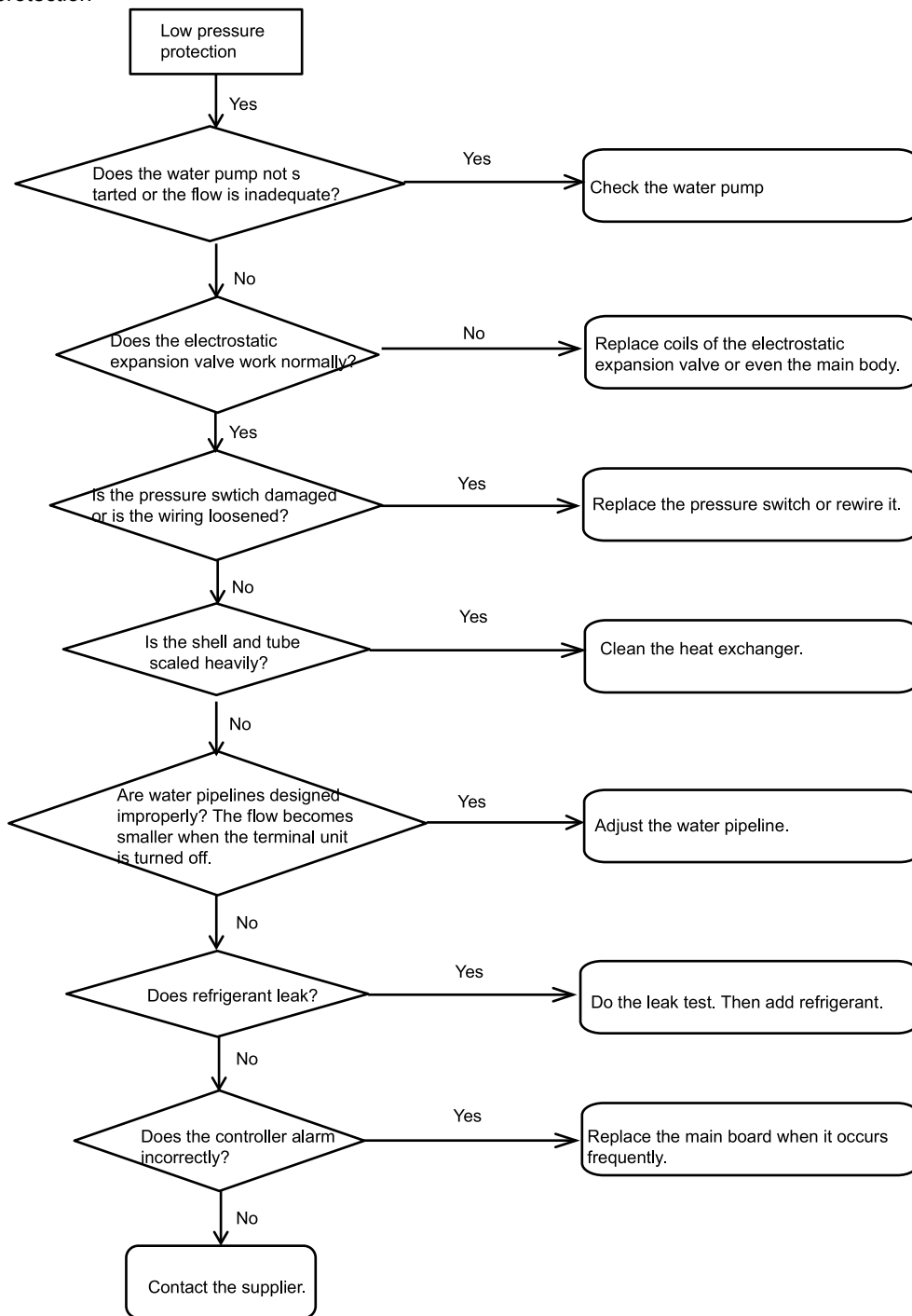

(3) High discharge protection

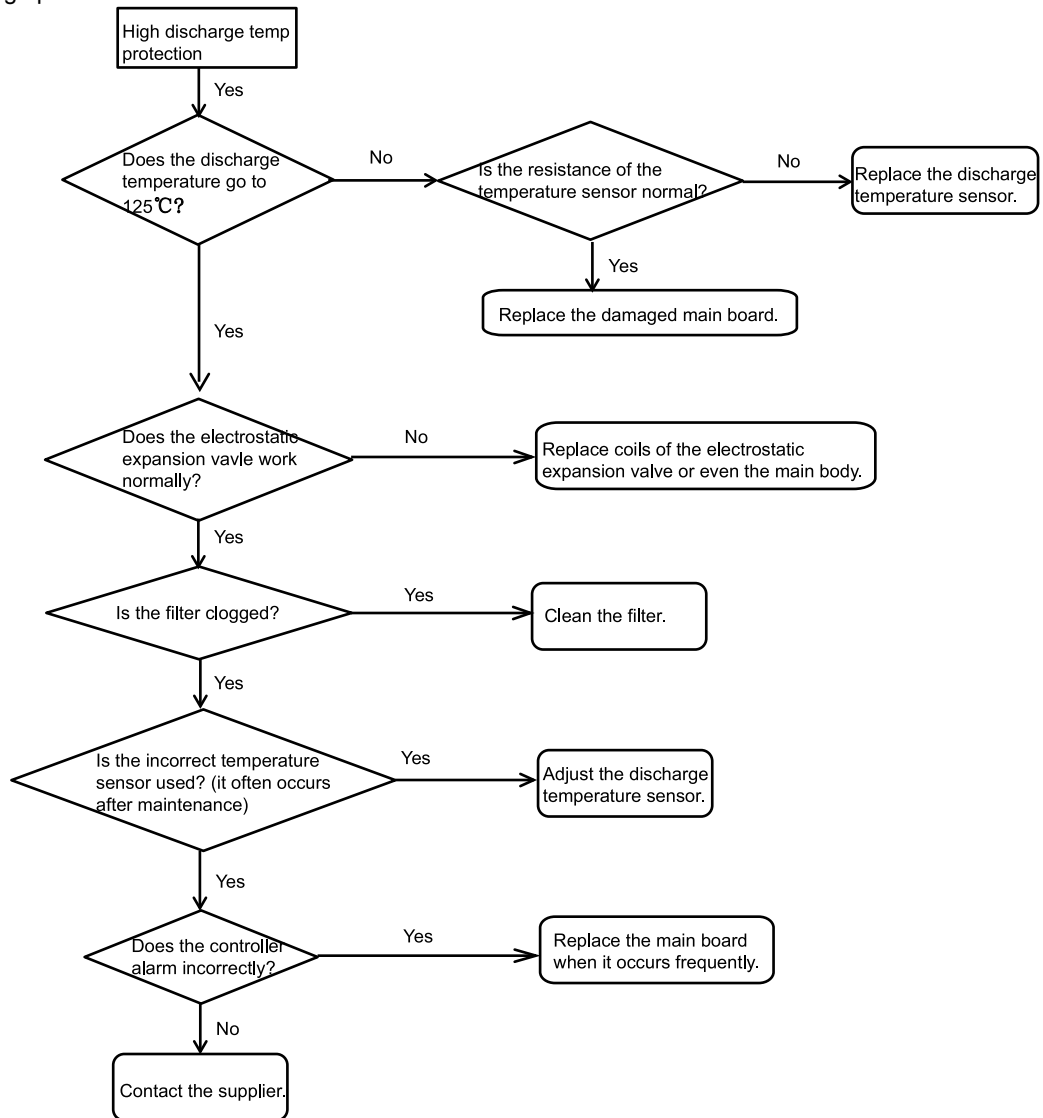

(4)Phase protection

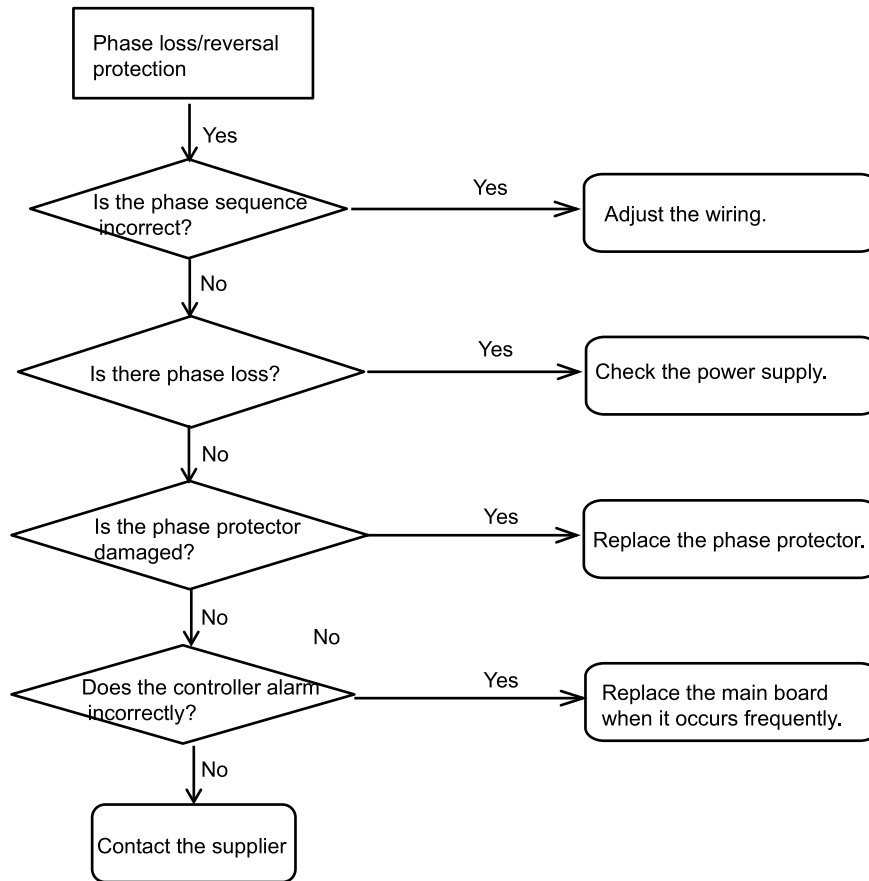

(5)Water flow switch protection

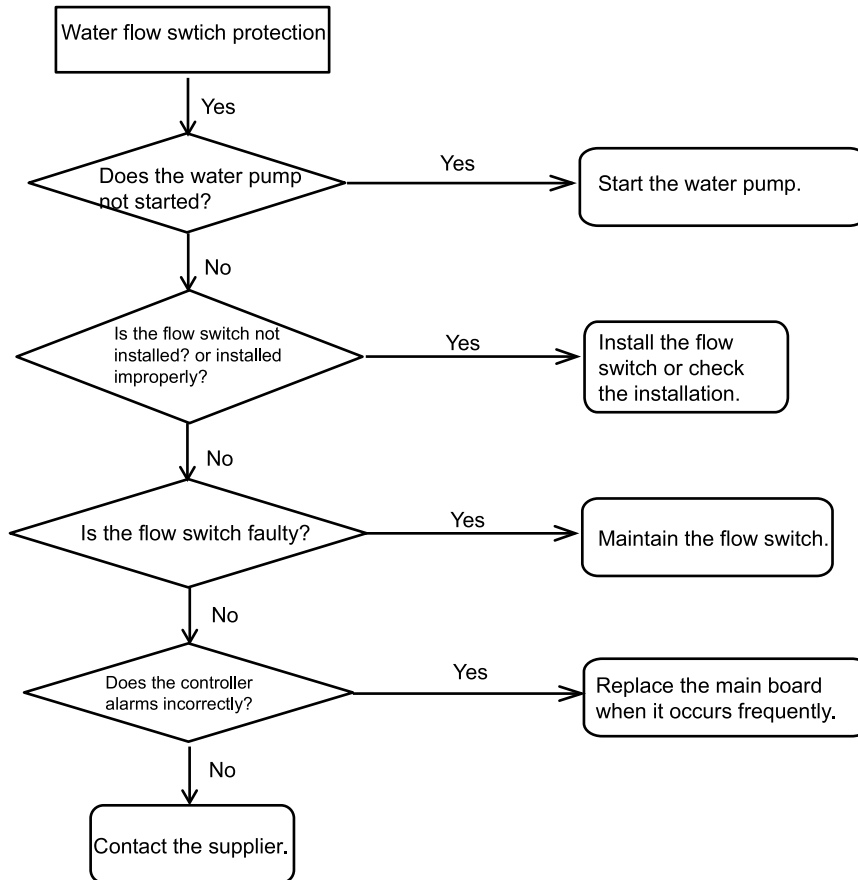

(6) Temperature sensor error

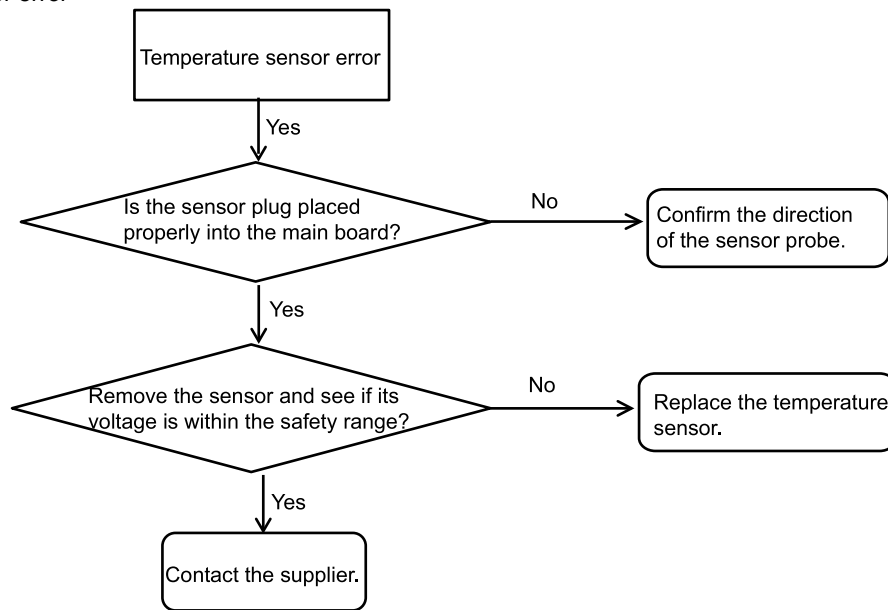

(7) Protection for the four-way valve

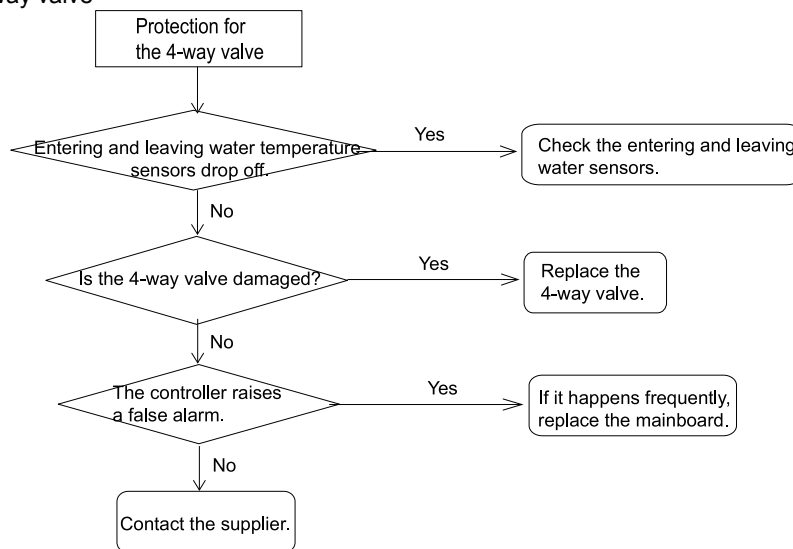

7.3 Power Distribution

7.3.1 Power Distribution Logic

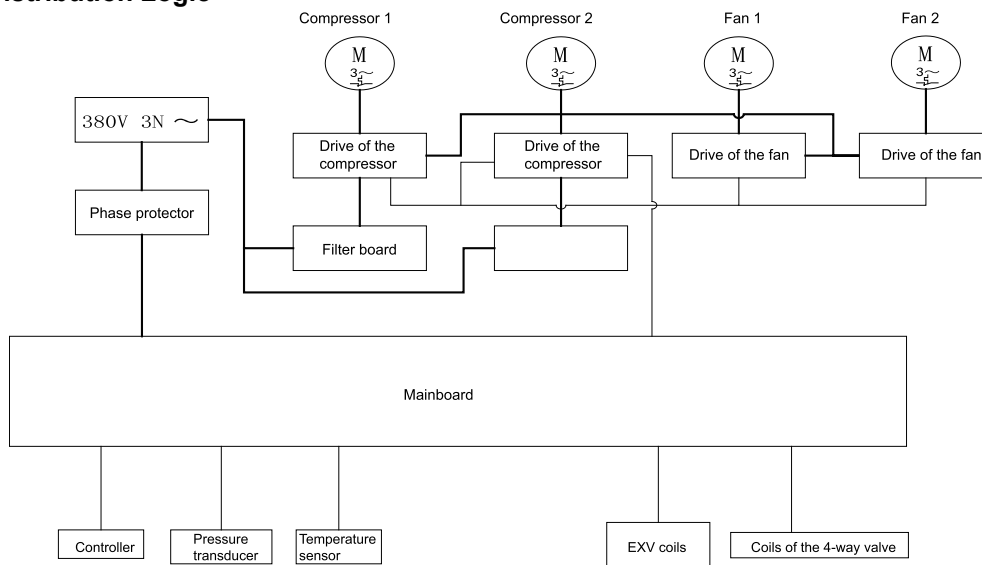

Note: bold lines indicate the main circuit and slim lines indicate the control circuit.



Phase protector

Protection conditions: phase loss or reversal of the power input for the phase protector.

Action result: No power for the controller and ON/OFF operation is failed.

Handling: interchange the wiring sequence and check if the voltage of the 3-phase power supply is normal.

7.3.2 Introduction to the Main Electric Element

	<p>Phase loss/reversal protector</p>	<p>It is used to check if the phase sequence of the power supply is correct or if there is power loss.</p>
	<p>Intermediate relay</p>	<p>It is used for the running and fault indicators.</p>

7.3.3 Main Board

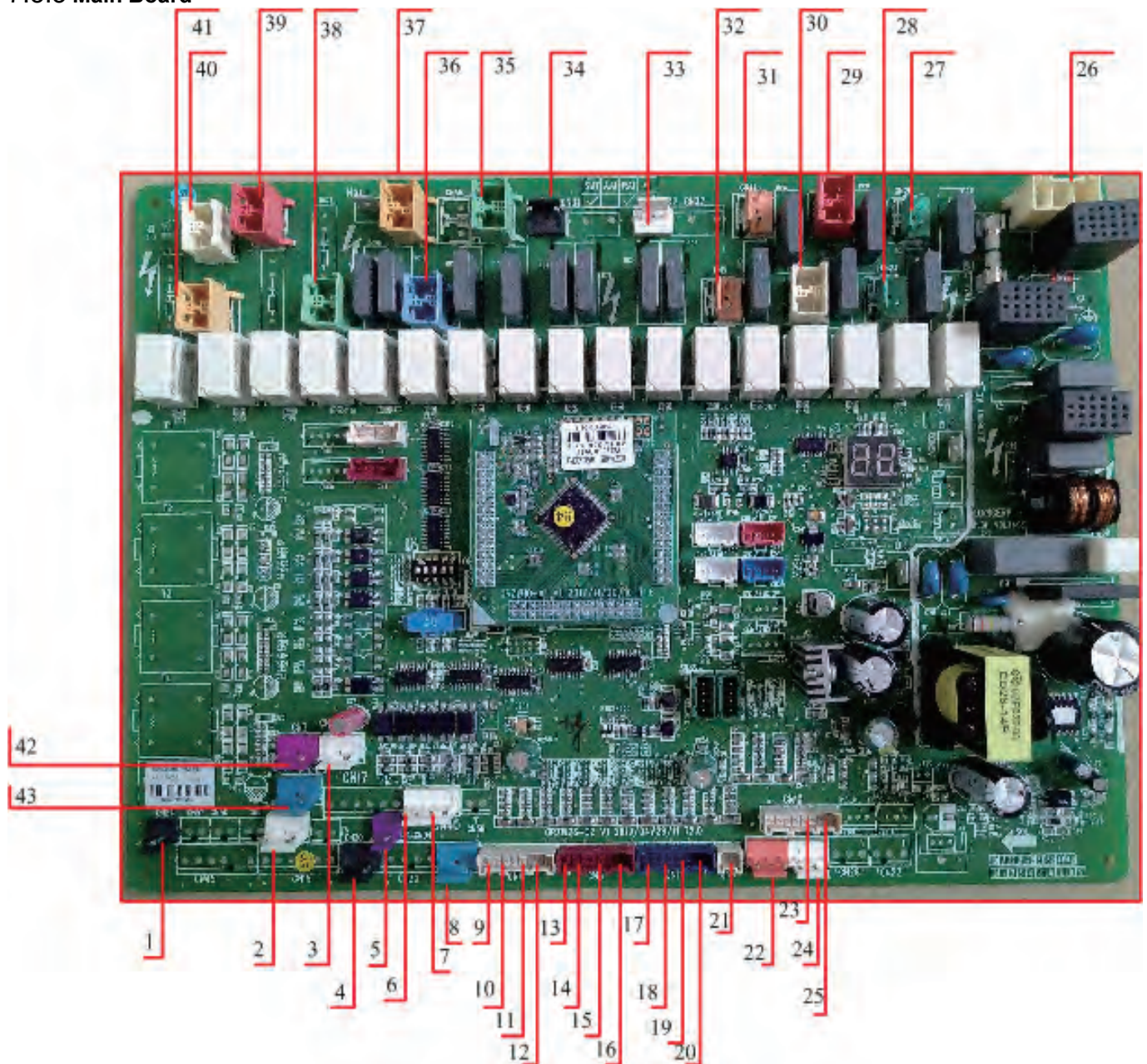

No	Name
1	water flow switch
2	System 2 low-pressure switch for heating
3	System 1 high-pressure switch
4	System 1 low-pressure switch for heating
5	External passive contact switch
6	Reserved
7	Reserved
8	System 1 low-pressure switch for cooling
9	Leaving water temp. sensor
10	Anti-freezing temp. sensor
11	System 1 defrosting temp. sensor
12	System 1 discharge temp. sensor
13	Inlet water temp. sensor
14	Reserved

15	System 2 defrosting temp. sensor
16	System 2 discharge temp. sensor
17	System 1 shell-and-tube inlet temp. sensor
18	System 2 shell-and-tube inlet temp. sensor
19	System 1 suction temp. sensor
20	System 2 suction temp. sensor
21	Outdoor ambient temp. sensor
22	System 1 high pressure sensor
23	System 2 shell-and-tube outlet temp. sensor
24	System 2 high pressure sensor
25	System 1 shell-and-tube outlet temp. sensor
26	220V input
27	COMP2 band heater 2
28	COMP2 band heater 1
29	4-way valve 2
30	4-way valve 1
31	COMP1 band heater 2
32	COMP1 band heater 1
33	Bottom band heater 2
34	Bottom band heater 1
35	Water pump 1
36	Auxiliary electrical heater 1
37	Auxiliary electrical heater 1
38	Water pump 2
39	Error indicating
40	Solenoid valve 2
41	Solenoid valve 1
42	System 2 high-pressure switch
43	System 2 low-pressure switch for cooling

7.4 Replacement of Main Parts

7.4.1 Brief Introduction



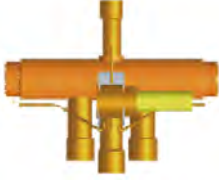



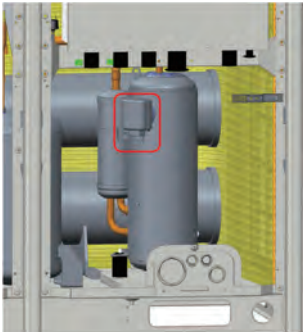
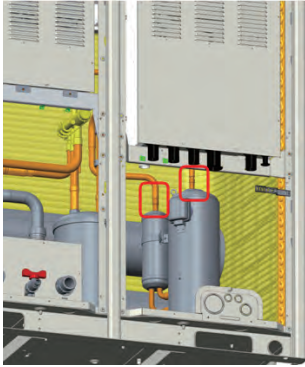
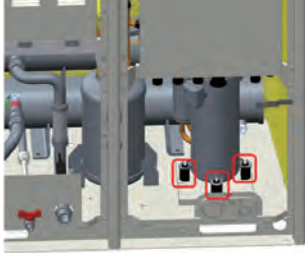
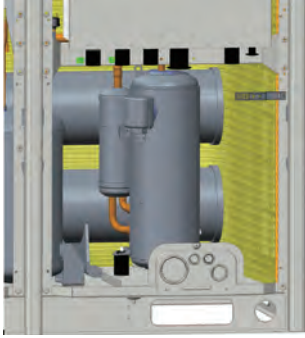
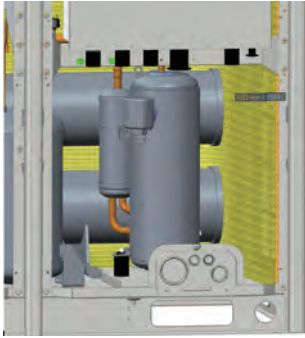

Image	Name	Function
	Compressor	It is the power source of the whole system, used to compress refrigerant to turn it to be high-pressure and high-temperature.
	Vapor-liquid separator	It is intended to separate refrigeration oil from liquid refrigerant.

Image	Name	Function
	Four-way valve	It is used to control the flow direction of refrigerant for either heating or cooling.
	Shell-and-tube heat exchanger	It is intended to conduct heat exchange between the refrigerant and the second refrigerant.
	Finned heat exchanger	At the cooling mode, it is intended to turn the high-temperature high-pressure refrigerant vapor into refrigerant liquid by releasing heat to the cooling medium. At the heating mode, it is intended to vaporize refrigerant liquid by absorbing heat from the cooling medium.
	Electronic expansion valve	It is intended to control refrigerant flow rate to make it match with the required load and make the refrigerant flowing into the evaporator evaporate completely.

7.4.2 Replacement Instructions



■ LSQWRF35VM/NaA-M



Replacement of the Compressor		
Note: be sure there is no refrigerant inside the system and power supply has been cut off before replacement.		
Steps	Image	Instructions
1. Remove the front panels.		<ol style="list-style-type: none"> (1) Remove screws at the front panel; (2) Loosened screws should be put together to avoid loss; (3) Pull the front panel upwards and then remove it; (4) Properly keep the removed front panel to avoid from being damaged. <p>Note: there are two clasps at each panel for connecting with side panels.</p>
2. Remove power lines and the electric heater.		<ol style="list-style-type: none"> (1) Remove the insulation of the compressor; (2) Loosen screws of power lines with a screwdriver; (3) Draw out power lines; (4) Draw out the electric heater. <p>Note: power lines and their terminals should be numbered to avoid incorrect rewiring.</p>

<p>3. Disconnect power lines to the compressor.</p>		<p>(1) Desolder pipes quick to avoid deformation; (2) Keep the replaced compressor complete for further analysis.</p>
<p>4. Loosen screws at feet of the compressor.</p>		<p>(1) Loosen screws at feet of the compressor with an adjustable or box spanner. (2) Loosened screws should be put together to avoid loss.</p>
<p>5. Replace the compressor with a new one.</p>		<p>(1) During replacement, care must be taken to not damage rubber pads; (2) Seal the replaced compressor to prevent moisture entering; (3) Place a new compressor at the rubber pads. Steel bushing is required for rubber pads; (4) Tighten the steel bushing with screws.</p>
<p>6. Reconnect the suction line, the discharge line, other pipes and electric lines. Then, check for normal operation of the compressor.</p>		<p>(1) Reconnect and resolder the suction and discharge lines. Do charge nitrogen during soldering; (2) After soldering, charge high-pressure nitrogen for the leak test. (3) Power on the unit and start it through a AC contact for 2~3 seconds; (4) When the compressor runs reversely, it would generate harsh noise.</p>
<p>7. Put back the front panels.</p>		<p>Put back front panels and tighten screws.</p>

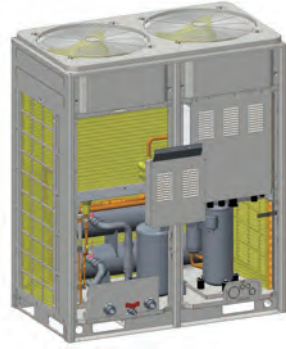
Note: there would be trapped oil inside the compressor during replacement, which would not affect its reliability but increase resistance to the rotors and then consume more power. In order to expel it, it would be better to install another valve at the lower

point of the suction line. After that, run the compressor for ten minutes and then open this valve until no oil comes out. Repeat this operation twice for normal oil level.



Replacement of the 4-way Valve		
<p>◦ Note: be sure power supply has been cut off and refrigerant has been reclaimed before replacement.</p>		
Steps	Image	Instructions
<p>1. Remove the front panel.</p>		<p>(1) Remove screws at the front panel;</p> <p>(2) Loosened screws should be put together to avoid loss;</p> <p>(3) Pull the front panel upwards and then remove it;</p> <p>(4) Properly keep the removed front panel to avoid from being damaged.</p> <p>Note: there are two clasps at each panel for connecting with side panels.</p>
<p>2. Remove the electric control box.</p>		<p>(1) Disconnect electric lines inside and outside of the electric box;</p> <p>(2) Protection measures should be taken to the internal elements to prevent them from being damaged.</p>
<p>3. Record the direction of the 4-way valve before de-soldering. The multi-system unit can not take other system as a example.</p>		<p>(1) Remember installation direction before replacement;</p> <p>(2) Remove coils;</p> <p>(3) Wrap it with wet cloth to keep its completeness for further analysis;</p> <p>(4) Desolder the 4-way valve.</p>

<p>4. Replace it with a new one and clean the system.</p>		<p>(1) Do not use the one with the same model for replacement. The one with a different model can be used after being approved by relative technicians;</p> <p>(2) Wrap it with a wet cloth;</p> <p>(3) Reconnect the main body with four pipes as before;</p> <p>(4) Solder the pipelines with a soldering gun.</p> <p>Do not charge nitrogen during desoldering.</p>
<p>5. Vacuum the system and recharge refrigerant.</p>		<p>(1) Keep the vacuum degree to — 1.0bar. The vacuuming period would be longer for the repaired unit;</p> <p>(2) Charged refrigerant should be the same as that stated at the nameplate.</p>

Replacement of the Electrostatic Expansion Valve

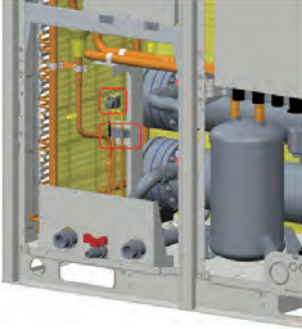
Note: check the whole system, pipelines and electric lines, cut off power supply and reclaim refrigerant before replacement.

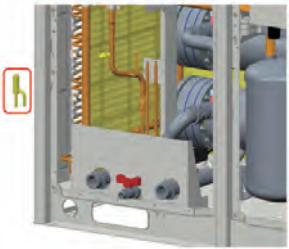



Steps	Image	Instructions
<p>1. Reclaim refrigerant and remove the middle panel.</p>		<p>(1) Cut off power supply of the unit;</p> <p>(2) Reclaim refrigerant;</p> <p>(3) Remove the middle panel.</p>
<p>2. Take out the coils, pipe clamps and rubber pads.</p>		<p>(1) Take out coils;</p> <p>(2) Loosen screws and take out pipe clamps and rubber pads;</p> <p>(3) Wrap the valve with a wet cloth to prevent the sliding block from being burnt out. In this case, care must be taken to not let water enter the pipe.</p>



<p>3. Desolder connection pipes.</p>		<p>(1)Desolder connection pipes and then disconnect them with the main body of the valve; (2)Do charge nitrogen during de-soldering; (3)Protection measures should be taken during soldering to prevent surrounding objects from being burnt out.</p>
<p>4. Take out the main body.</p>		<p>Take out the main body of the electrostatic expansion valve.</p>
<p>5. Replace it with a new one.</p>		<p>(1)Solder pipes; (2)Do charge nitrogen during soldering; (3)Protection measures should be taken during soldering to prevent surrounding objects from being burnt out.</p>
<p>6. Tighten coils, pipe clamps and rubber pads; vacuum the system; recharge refrigerant and then put back the panel.</p>		<p>(1)The bulge of the coil should match with the recess of the main body of the valve; (2)Keep the vacuum degree to -1.0bar. Vacuuming period would be longer for the repaired unit; (3)Charged refrigerant should be the same as that stated at the nameplate; (4)Power off the unit and then power it on again; (5)Put back the panel.</p>

Replacement of Vapor-liquid Separator

Note: properly reclaim refrigerant, prepare tools and keep good ventilation.

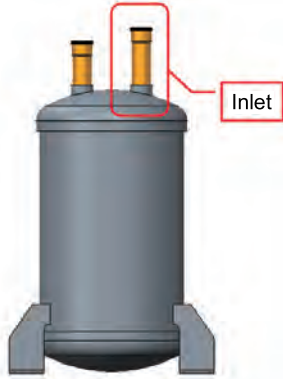

Steps	Image	Instructions
<p>1. Remove front panels.</p>		<p>(1)Remove screws at the front panel; (2)Loosened screws should be put together to avoid loss; (3)Pull the front panel upwards and then remove it; (4)Properly keep the removed front panel to avoid from being damaged. Note: there are two clasps at each panel for connecting with side panels.</p>

<p>2. De-solder connection pipes.</p>		<p>De-solder connection pipes with a soldering gun.</p>
<p>3. Take out the vapor-liquid separator.</p>		<p>Loosen fixed screws and take out the vapor-liquid separator.</p>
<p>4. Clean the system by charging nitrogen.</p>		<p>(1)Connect a nitrogen line. When its size is quite large, use adhesive tape for help to keep nitrogen naturally go into the vapor-liquid separator. (2)Clean the system by charging nitrogen.</p>
<p>5. Replace it with a new one.</p>		<p>Install the new vapor-liquid separator as per reverse steps as stated above.</p>

<p>6. When it is required to add lubricating oil, charge it from the inlet of the vapor-liquid separator before soldering.</p>		<p>Charge lubrication oil from the inlet of the vapor-liquid separator and then do soldering.</p>
<p>7. Reconnect pipes; vacuum the system; recharge refrigerant and then put back the panel.</p>		<ol style="list-style-type: none"> (1) Solder pipes and do charge nitrogen during soldering; (2) Keep the vacuum degree to -1.0bar. Vacuuming period would be longer for the repaired unit; (3) Charged refrigerant should be the same as that stated at the nameplate;

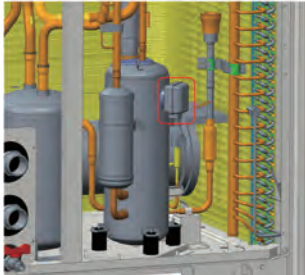
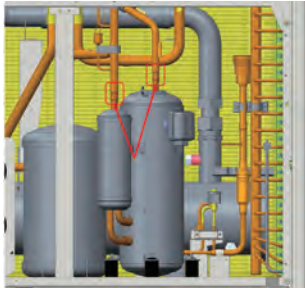
■ LSQWRF60VM/NaA-M

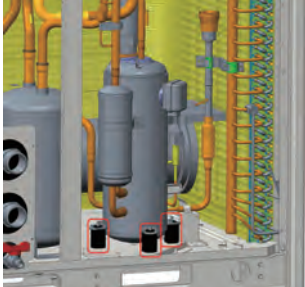
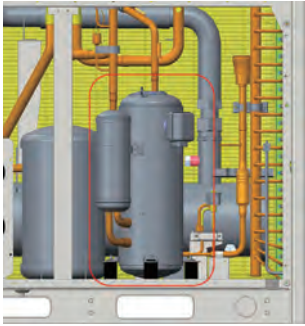
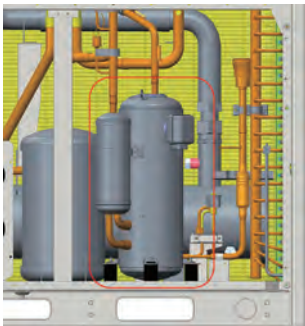
Replacement of the Compressor		
Note: be sure there is no refrigerant inside the system and power supply has been cut off before replacement.		
Steps	Image	Instructions
<p>1. Remove the front panels.</p>		<ol style="list-style-type: none"> (1) Remove screws at the front panel; (2) Loosened screws should be put together to avoid loss; (3) Pull the front panel upwards and then remove it; (4) Properly keep the removed front panel to avoid from being damaged. <p>Note: there are two clasps at each panel for connecting with side panels.</p>
<p>2. Remove power lines and the electric heater.</p>		<ol style="list-style-type: none"> (1) Remove the insulation of the compressor; (2) Loosen screws of power lines with a screwdriver; (3) Draw out power lines; (4) Draw out the electric heater. <p>Note: power lines and their terminals should be numbered to avoid incorrect rewiring.</p>
<p>3. Disconnect power lines to the compressor.</p>		<ol style="list-style-type: none"> (1) Desolder pipes quick to avoid deformation; (2) Keep the replaced compressor complete for further analysis.

<p>4. Loosen screws at feet of the compressor.</p>		<ol style="list-style-type: none"> (1) Loosen screws at feet of the compressor with a adjustable or box spanner. (2) Loosened screws should be put together to avoid loss.
<p>5. Replace the compressor with a new one.</p>		<ol style="list-style-type: none"> (1) During replacement, care must be taken to not damage rubber pads; (2) Seal the replaced compressor to prevent moisture entering; (3) Place a new compressor at the rubber pads. Steel bushing is required for rubber pads; (4) Tighten the steel bushing with screws.
<p>6. Reconnect the suction line, the discharge line, other pipes and electric lines. Then, check for normal operation of the compressor.</p>		<ol style="list-style-type: none"> (1) Reconnect and resolder the suction and discharge lines. Do charge nitrogen during soldering; (2) After soldering, charge high-pressure nitrogen for the leak test. (3) Power on the unit and start it through a AC contact for 2~3 seconds; (4) When the compressor runs reversely, it would generate harsh noise.
<p>7. Put back the front panels.</p>		<p>Put back front panels and tighten screws.</p>

Note: there would be trapped oil inside the compressor during replacement, which would not affect its reliability but increase resistance to the rotors and then consume more power. In order to expel it, it would be better to install another valve at the lower point of the suction line. After that, run the compressor for ten minutes and then open this valve until no oil comes out. Repeat this operation twice for normal oil level.

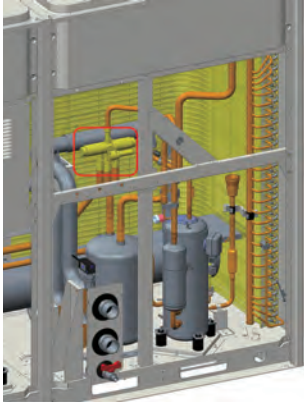
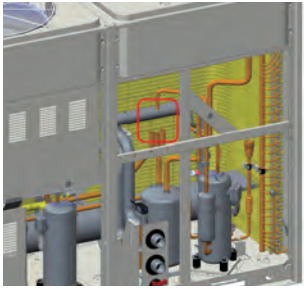
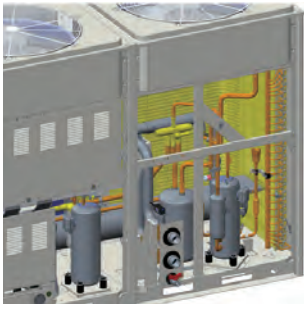

Replacement of the 4-way Valve		
Note: be sure there is no refrigerant inside the system and power supply has been cut off before replacement.		
Steps	Image	Instructions
<p>1. Remove the front panel.</p>		<ol style="list-style-type: none"> (1) Remove screws at the front panel; (2) Loosened screws should be put together to avoid loss; (3) Pull the front panel upwards and then remove it; (4) Properly keep the removed front panel to avoid from being damaged. <p>Note: there are two clasps at each panel for connecting with side panels.</p>

<p>2. Remove the electric control box.</p>		<ol style="list-style-type: none"> (1) Disconnect electric lines inside and outside of the electric box; (2) Protection measures should be taken to the internal elements to prevent them from being damaged.
<p>3. Record the direction of the 4-way valve before de-soldering. The multi-system unit cannot take other system as a example.</p>		<ol style="list-style-type: none"> (1) Remember installation direction before replacement; (2) Remove coils; (3) Wrap it with wet cloth to keep its completeness for further analysis; (4) Desolder the 4-way valve.
<p>4. Vacuum the system and recharge refrigerant.</p>		<ol style="list-style-type: none"> (1) Keep the vacuum degree to -1.0bar. Vacuuming period would be longer for the repaired unit; (2) Charged refrigerant should be the same as that stated at the nameplate.

Replacement of the Electrostatic Expansion Valve

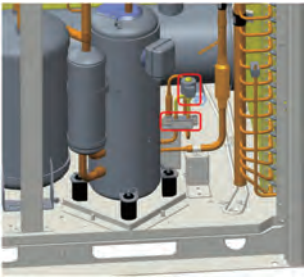
Note: be sure there is no refrigerant inside the system and power supply has been cut off before replacement.

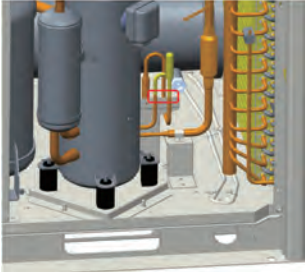
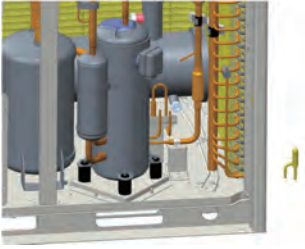
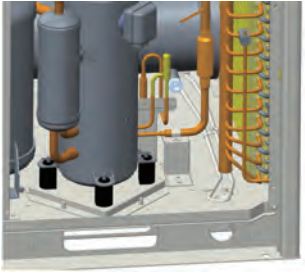
Steps	Image	Instructions
<p>1. Reclaim refrigerant and remove the middle panel.</p>		<ol style="list-style-type: none"> (1) Cut off power supply of the unit; (2) Reclaim refrigerant; (3) Remove the middle panel.
<p>2. Take out the coils, pipe clamps and rubber pads.</p>		<ol style="list-style-type: none"> (1) Take out coils; (2) Loosen screws and take out pipe clamps and rubber pads; (3) Wrap the valve with wet cloth to prevent the sliding block from being burn out. In this case, care must be taken to not let water enter the pipe.

<p>3. Desolder connection pipes.</p>		<p>(1)Desolder connection pipes and then disconnect them with the main body of the valve; (2)Do charge nitrogen during de-soldering; (3)Protection measures should be taken during soldering to prevent surrounding objects from being burnt out.</p>
<p>4. Take out the main body.</p>		<p>Take out the main body of the electrostatic expansion valve.</p>
<p>5. Replace it with a new one.</p>		<p>(1)Solder pipes; (2)Do charge nitrogen during soldering; (3)Protection measures should be taken during soldering to prevent surrounding objects from being burnt out.</p>
<p>6. Tighten coils, pipe clamps and rubber pads; vacuum the system; recharge refrigerant and then put back the panel.</p>		<p>(1)The bulge of the coil should match with the recess of the main body of the valve; (2)Keep the vacuum degree to -1.0bar. Vacuuming period would be longer for the repaired unit; (3)Charged refrigerant should be the same as that stated at the nameplate; (4)Power off the unit and then power it on again; (5)Put back the panel.</p>

7.5 Routine Repair

7.5.1 Repairs to Refrigerant Leakage

When soapsuds often used to detect leakage of a refrigeration system is applied to possible leakage points. If there are bubbles, leaks occur and need repairs by brazing. If soapsuds does not work, an electronic leak detector is an alternative. Intake and exhaust pressures indicate refrigerant charge. If leaks exist or parts are going to be replaced, leakage test must be taken. Refrigerant charges in two following cases should be treated in different manners.

(1)Full leaks

A leak test for the system must be taken with high-pressure nitrogen (15 ~ 20 kg) or refrigerant. If brazing is needed, gases in the system must be evacuated. The system must be treated with vacuum pumping before refrigerant charges.

- 1) Connect evacuation pipes with fluorine nozzles at low-pressure and high-pressure sides;

2) Vacuumize the system piping by a vacuum pump.

Procedures (one system as an example):

Step 1: Remove the high-pressure nitrogen that was used for the leak test.

Step 2: Fix pressure gauges to fluorine nozzles of high-pressure and low-pressure valves (note: vacuum pumping should be done with both valves in the meantime.). Either of two dials must register low pressures since only its readings indicate vacuum.

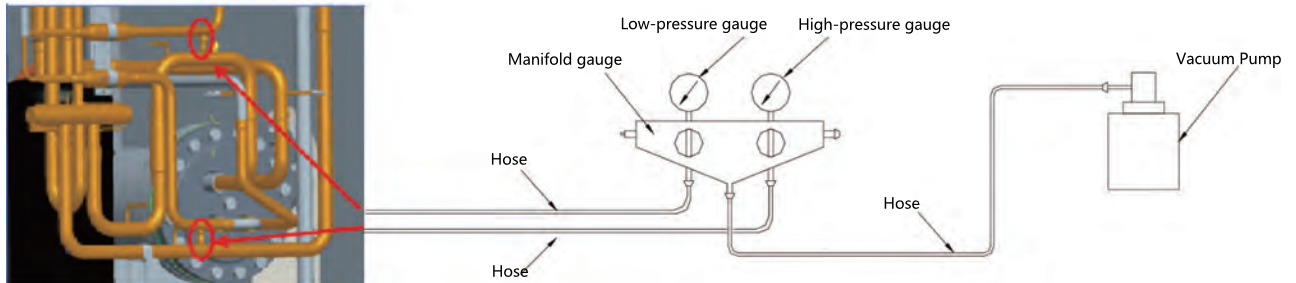

Figure 7-1 Vacuum pumping

Step 3: Turn on switches at low-pressure and high-pressure sides. Start a vacuum pump let it continues for 0.5 ~ 1.0 hour after the reading of a pressure gauge falls to -1bar;

Step 4: Close the valves connected to the vacuum pump shown in the figure above and then shut down the pump (notice: it must be done in this order, or gases will enter the system again.)

Step 5: Take a pressure test to make sure that the pressure of the system is no less than 80Pa and will not noticeably rebound within 1 hour.

Up to now, vacuum pumping has been finished.

3) Keep the pressure for 30 minutes, and charge refrigerant when the pressure is no more than 100Pa. Start charging according to the proper volume indicated by the nameplate and main technical parameters table.

(2)Recharge refrigerant

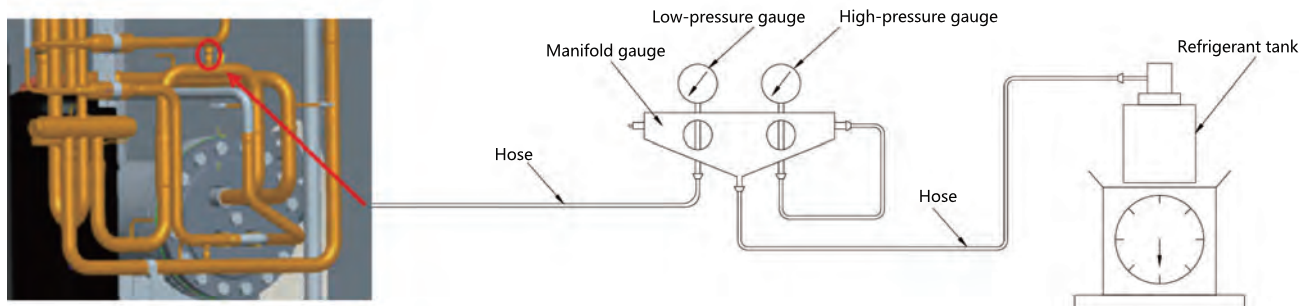

Figure 7-2 Charging process

Excessive or deficient refrigerant may cause abnormal operation, malfunction or damage to a compressor, so charge volume must comply with the requirements on the unit nameplate which have been decided in strict tests; The figure may serve as a reference; a charge process is as follows (one system as an example):

Step 1: Place a refrigerant container on an electronic scale and connect the container and the pressure gauges by a flexible tube;

Step 2: Remove gases inside the flexible tube—half turning the shut-off valve of the container, loosen the joint device between the flexible tube and pressure gauge; tighten the joint device when a sound is sent out for 5s;

Step 3: Power up and down the electronic scale to enable it to reset;

Step 4: Ensure that the flexible tube has been evacuated and the scale reset, turn on all valves connecting refrigerant containers and the unit; charge refrigerant required by the nameplate to prevent oil dilution caused by excessive charging, and inhibit a capacity decline of the unit induced by insufficient charging; when the unit is running, make sure it is gaseous refrigerant (as possible as it can be) from a refrigerant container (that cannot be turned upside down) that is injected into fluorine

nozzles on intake lines; when the unit powered down, be sure to charge refrigerant the fluorine nozzle at the high-pressure side (if there is no nozzle at the high-pressure side, low-pressure side is an alternative.) in case of liquid slug.

7.5.2 Air Removal

When there is air trapped in the system, expel them before charging refrigerant. The whole system must be vacuumed as per steps stated below.

- (1) Connect pipes for vacuuming at both the low and high pressure sides;
- (2) Start the vacuum pump for vacuuming;
- (3) When it reaches the targeted vacuum degree, charge refrigerant into the system. See the nameplate for type and charging amount of refrigerant. Do charging from the low pressure side. A manifold gauge should be connected to both the low and high pressure sides;
- (4) Refrigerant charging would be affected by environment temperature. If refrigerant is undercharged, start the water pump to circulate chilled water and meanwhile start the unit for refrigerant adding. In this case, vapor refrigerant should be charged.

7.6 Exploded Views and Part Lists

■ LSQWRF35VM/NaA-M

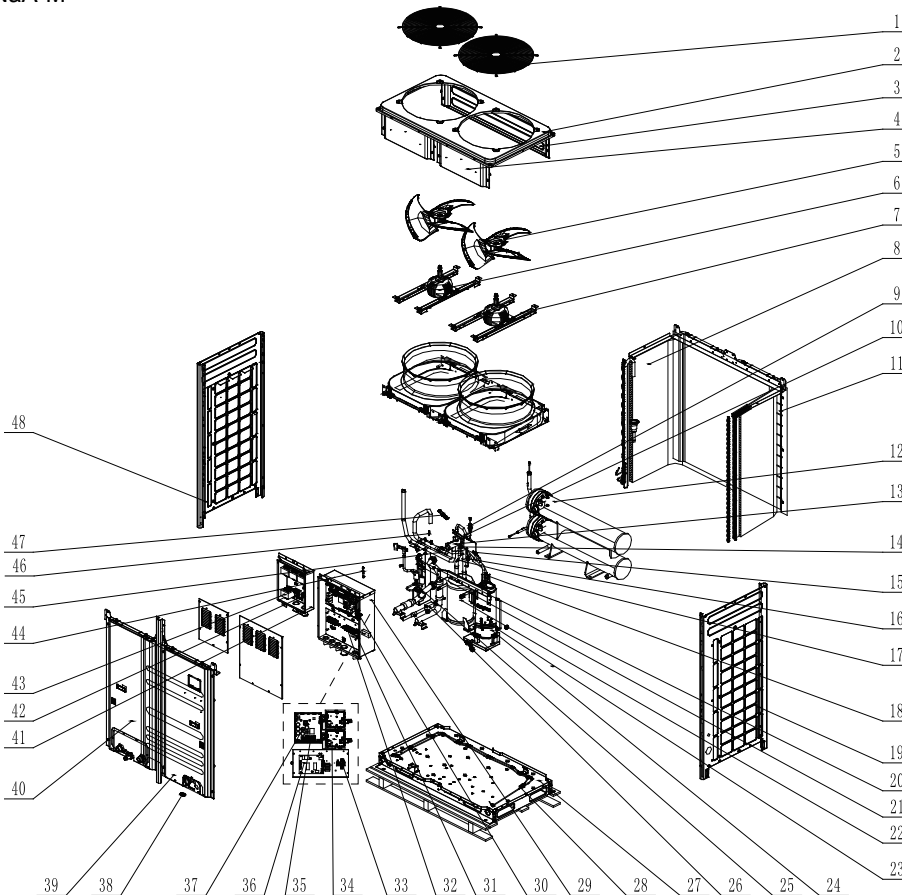

■ LSQWRF35VM/NaA-M (EL01500750) Part List

No.	Name of part	Part code
1	Rear Grill	01574100002
2	Coping	01264100006P
3	Top Cover (front)	01264100004P
4	Upper Cover Plate (back)	01264100005P
5	Axial Flow Fan	10434100002
6	Brushless DC Motor	15704124
7	Motor Support Sub-Assy	01804771P
8	Condenser Assy	01100206025101
9	Pressure Sensor	322101032
10	Magnet Coil	4300040030

A Series Modular-type Air-cooled (Heat Pump) Chiller

11	Rear Grill	01574100001
12	Dry Evaporator	011101060013
13	4-way Valve	43000339
14	Pressure Protect Switch	4602001595
15	Pressure Protect Switch	4602000911
16	Pressure Protect Switch	4602001596
17	Temp Sensor Sleeving	05212423
18	Temp Sensor Sleeving	05210001
19	Electric Expansion Valve	43044100190
20	Left Side Plate	01314712P
21	Electric Expand Valve Fitting	4304413228
22	Gas-liquid Separator	035027000020
23	Electrical Heater(Compressor)	7651873225
24	Compressor and Fittings	009001060081
25	Strainer	0721212101
26	Steam current Switch	430019000004
27	Base Frame Assy	000043060085
28	Electrical Heater (Chassis)	7651000411
29	Electric Box Assy	100002062997
30	Main Board	300027060166
31	Intermediate relay	44020338
32	Terminal board	422000000010
33	Phase Reverse Protector	32214101
34	Main Board	300027060523
35	Rectifier bridge	46010604
36	Filter board	30228000015
37	Main Board	300027060164
38	Gland Bush	26904100134
39	Front Panel (right)	01544100005P
40	Left Front Panel	01542800031P01
41	Electric Box Assy	100002064468
42	Terminal board	42018000593
43	Reactor	450004060009
44	One Way Valve	07338000112
45	Filter	07218603
46	Sensor Sub-assy	390002060049
47	Temperature Sensor Support	26904100025
48	Right Side Plate	01314713P

■LSQWRF60VM/NaA-M、LSQWRF65VM/NaA-M

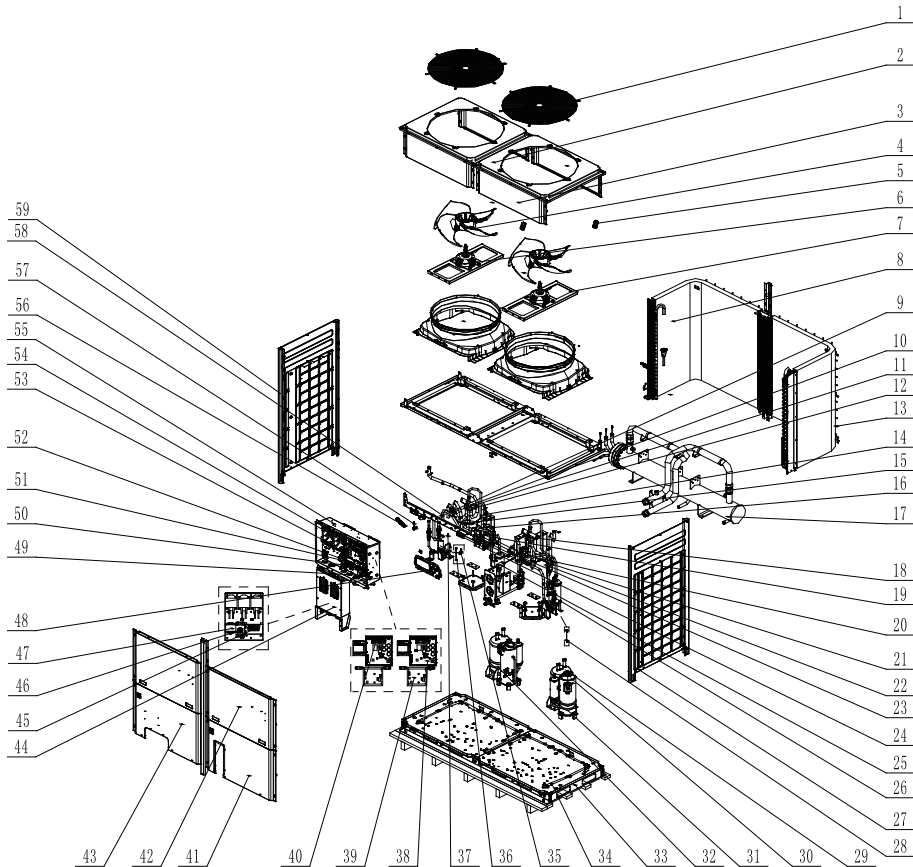

■ LSQWRF60VM/NaA-M(EL01500720)、LSQWRF65VM/NaA-M(EL01500760) Part List

No.	Name of part	Part code
1	Rear Grill	01574100016
2	Coping	01264100056P
3	Top Cover	01264100057P
4	Axial Flow Fan	103002000007
5	Axial Flow Fan nesting	02204102
6	Brushless DC Motor	1570412401
7	Motor Support Sub-Assy	017012060044P
8	Condenser Assy	011002060230
9	Temp Sensor Sleeving	05212423
10	4-way Valve	43000339
11	Filter	07218603
12	Magnet Coil	4300040064
13	Rear Grill 1	01574100017
14	Pressure Protect Switch	4602001595
15	Pressure Protect Switch	4602001596
16	Pressure Sensor	322101037
17	Dry Evaporator	011101060008
18	4 Way Valve Coil	4300040095
19	Pressure Protect Switch	4602000911
20	Pressure Protect Switch	4602001599
21	Pressure Protect Switch	4602001535
22	Pressure Sensor	322101032
23	Pressure Protect Switch	46020015114

24	Handle	26904100016
25	Steam current Switch	4502800000907
26	Strainer	07210037
27	Right Side Plate	01314100099P
28	Electric Expand Valve Fitting	4304413213
29	Gas-liquid Separator	035027000020
30	Compressor and Fittings	009001060081
31	Electrical Heater(Compressor)	7651873225
32	Electrical Heater(Compressor)	7651873222
33	Base Frame Assy	000043060065
34	Electrical Heater (Chassis)	7651000411
35	Electric Expansion Valve	43044100190
36	Electric Expand Valve Fitting	4304413207
37	Temp Sensor Sleeving	05210001
38	Main board	300027060164
39	Main board	300027060523
40	Rectifier bridge	46010604
41	Right Front Panel	01542800035
42	Left Front Panel	01544100026P
43	Left Front Panel	01544100027P
44	Electric Box Assy	100002064410
45	Terminal Board	422000000016
46	Terminal Board	420001000008
47	Reactor	450004060009
48	Bottom Cover Plate	01264100048
49	Intermediate relay	44020338
50	Terminal Board	422000000024
51	Phase sequence protector	32214101
52	Terminal Board	422000060011
53	Filter board	30228000015
54	Main board	300027060166
55	Electric Box Assy	100002061680
56	Temperature Sensor Support	26904100025
57	One Way Valve	0733420001
58	Sensor Sub-assy	390002060032
59	Left Side Plate	01314100098P

8 Maintenance

8.1 Significant of Maintenance

The unit has undergone a series of strict tests prior to delivery to ensure qualified performance, however, in order to keep reliable performance and extend its service life, the unit should be maintained routinely and periodically by the qualified servicemen.

8.2 Maintenance Items

8.2.1 Routine Maintenance Items

Routine Maintenance Items
Is there any unusual noise and vibration?

Is there any unusual noise and vibration for the compressor in operation? Is there any unusual smell?
Do the operating pressure, voltage and current keep normal? If not, figure out the cause and then eliminate it?
Are all temperature sensors and pressure transducers installed securely?

8.2.2 Periodic Maintenance Items

Periodic Maintenance Items
Is any wiring loosened and insulated securely?
Does any electric element work reliably? If not, change it timely?
Does any throttling valve and control valve leaks? Can any valve be opened or closed flexibly? Is any filter clogged?
Is the temperature set point proper?
Is there a large amount of condensate at the chilled water pipe or the condensate pipe? Is insulation layer damaged?

8.2.2.1 Requirements on Water Quality and Cleaning

Industrial water used as chilled water produces little scale, but well or river water will bring much scale, sand and other sediment which then would block up the chilled water flow and make the evaporator frozen up. Therefore, it is necessary to filter or chemically soften water before it flows into the water system and also take analysis to quality. Once it is found water quality is dissatisfactory, and then only industrial water is available.

Requirements on Water Quality						
Item			Chilled/Hot water side		Trend	
			Circulating water	Supply water	Corrosion	Scalelike sediment
Basic items	PH(25°C)	6.8-8.0	6.8-8.0	6.8-8.0	0	
	Conductivity(25°C)	µs/cm	<400	<300	0	0
	Cl ⁻	mg(Cl ⁻)/L	<50	<50	0	
	SO ₄ ²⁻	mg(SO ₄ ²⁻)/L	<50	<50	0	
	Acid consumption (PH4.8)	mg(CaCO ₃)/L	<50	<50		0
	Hardness	mg(CaCO ₃)/L	<70	<70		0
Reference items	Fe	mg(Fe)/L	<1.0	<0.3	0	0
	S ²⁻	mg(S ²⁻)/L	undetecable	undetecable	0	
	NH ₄ ⁺	mg(NH ₄ ⁺)/L	<1.0	<0.3	0	
	SiO ₂	mg(SiO ₂)/L	<30	<30		0

Note: "0" in the table above indicates the cause for corrosion and scalelike sediment.

Even though water quality is under strict control, calcium oxide or other minerals will gradually accumulate on the surface of the evaporator. Then, it will reduce the heat exchange efficiency of the evaporator and consequently lead to poor performance of the unit.

Therefore, the pipe system should be cleaned periodically. Oxalic acid, acetic acid and formic acid can be used as the organic cleaning agent, but the strong chloracid is not allowed as it will corrode the copper tube of the heat exchanger and then lead to water and refrigerant leakage.

■ Preparation of Materials and Tools

Several bags of environmental friendly scale remover, or similar cleaning liquid.

■ Cleaning Instructions

- (1) estimate the required amount of scale remover in accordance with the system water volume and severity of scaling.
- (2) add the scale remover to the water tank and the scale remover.
- (3) start through the contact the water pump every 10 minutes and spread the scale remover in water more quickly and widely.
- (4) after that, follow the steps below
 - 1) let the water pump run for another 1-2 hours.

- 2) 1-2 hours later, change the cleaning solution to anti-rusting agent. Then, drain the water system and check the water quality. If water is cloudy, then it indicates the cleaning effect is satisfactory.
- 3) open the water inlet to see if scale on the shell and tube has been removed. If not, clean the shell and tube separately again by the skilled serviceman and then rinse them. If there is still sand, scale and other foreign matters at the bottom of the shell and tube, let cleaning solution in from the inlet pipe and then let the foul water out through the drain outlet.
- 4) fully charge the water system and let it run for another 1-2 hours.
- 5) stop the unit to drain up waste solution. If impossible, drain it with making up water at the same time until all waste solution has been drained out completely (at this time water is transparent and PH is 7).
- 6) repeat steps ④ and ⑤.
- 7) clean or change the filters in the water system.
- 8) see if the difference between the entering and leaving water temperature is improved.

△ NOTE

- (1) although the cleaning agent is innocuous, but care also should be taken not to let it spill into eyes.
- (2) the serviceman with injuries on the hand is not allowed to take this task.

Before and after cleaning, observe the running status of the unit, summarize the cleaning effect and record the running parameters.

8.2.2.2 Cleaning of the Finned Heat Exchanger

In order to keep fins work efficiently, be sure there are no leaves, cotton wool, insects, and other contaminants on the outer layer of fins, or they would lead to more energy consumption and high discharge pressure. Generally, fins should be cleaned after the unit has run for 6-12 months, or more frequently when the environment is polluted more seriously.

- (1) Cut off the power supply.
- (2) Clean with high-pressure air fins against the direction of the inlet air, or clean with high-pressure water fins at the direction upright with that of the fins but care must be taken to control the water pressure to prevent the fins from being pulled down and protect each electric element. If fins stick with oily matters, clean fins with neutral detergent solution.
- (3) The vacuum cleaner and nylon brush also can be used to remove dust and foreign matters on the surface of the heat exchanger.

8.3 Freeze Protection in Winter

When the unit is not going to be used for a long time, clean and dry the internal and external surfaces of the unit, and then it would be better to wrap it. Under the subzero climate, the unused unit should be drained completely so that the shell-and-tube evaporator would not be frozen up. Instead, the other way is adding some antifreeze into water to keep the water temperature no less than 0°C.

See the following steps for how to drain water out.

- (1) Loosen screws on the front panel and then remove the front panel
- (2) Draw out the blind plug counter clockwise to let the chilled water flow out freely until no water stays in. After that, place the blind plug back. (Note: put the container for foul water beneath the drain pipe to prevent foul water from polluting the site).

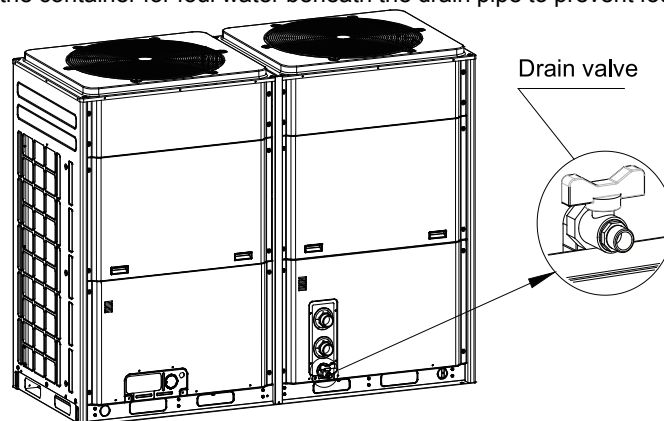



GREE ELECTRIC APPLIANCES, INC. OF ZHUHAI

Add: West Jinji Rd, Qianshan Zhuhai, Guangdong, China 519070

Tel: (+86-756)8522218

Fax: (+86-756)8669426

E-mail: gree@gree.com.cn www.gree.com